

TPS7A85

高电流 (4A)、高效 (1%)、低噪声 (4.4 μV_{RMS}) LDO 稳压器

1 特性

- 低压降：4A 电流时为 150mV（典型值）
- 线路、负载和温度精度为 1%（最大值）
- 输出电压噪声：
 - 4.4 μV_{RMS} （输出为 0.8V）
 - 8.4 μV_{RMS} （输出为 5.0V）
- 输入电压范围：
 - 无偏置：1.4V 至 6.5V
 - 有偏置：1.1V 至 6.5V
- ANY-OUT™ 运行：
 - 输出电压范围：0.8V 至 3.95V
- 可调节运行：
 - 输出电压范围：0.8V 至 5.0V
- 电源纹波抑制：
 - 500kHz 时为 40dB
- 出色的负载瞬态响应
- 可调节软启动浪涌电流控制
- 开漏电源正常 (PG) 输出
- 与 47 μF 或更大的陶瓷输出电容一起工作时保持稳定
- 工作温度范围：
 - 40°C 至 +125°C
- 20 引脚 3.5mm x 3.5mm 超薄型四方扁平无引线 (VQFN) 封装

2 应用

- 数字负载：串行解串器、现场可编程门阵列 (FPGA) 和数字信号处理器 (DSP)
- 仪器仪表、医疗和音频
- 高速模拟电路：
 - 压控振荡器 (VCO)、模数转换器 (ADC)、数模转换器 (DAC) 以及低压差分信令 (LVDS)
- 成像：互补金属氧化物半导体 (CMOS) 传感器和视频专用集成电路 (ASIC)
- 测试和测量

3 说明

TPS7A85 是一款低噪声 (4.4 μV_{RMS})、低压降 (LDO) 线性稳压器，具备 4A 的拉电流能力，其最高压降仅为 240mV。该器件的输出电压可通过引脚在 0.8V 至 3.95V 的范围内进行编程并可通过外部电阻分压器在 0.8V 至 5.0V 范围内进行调节。

TPS7A85 将低噪声 (4.4 μV_{RMS})、高电源抑制比 (PSRR) 和高输出电流性能相结合，非常适合为高速通信、视频、医疗或测试和测量最高可驱动 1A 负载电流。TPS7A85 的高性能可限制电源生成的相位噪声和时钟抖动，非常适合为高性能串行器和解串器 (SerDes)、模数转换器 (ADC)、数模转换器 (DAC) 以及射频 (RF) 组件供电。RF 放大器尤其受益于该器件的高性能和 5.0V 输出性能。

对于需要以低输入电压、低输出 (LILO) 电压运行的数字负载 [如特定用途集成电路 (ASIC)、现场可编程门阵列 (FPGA) 以及数字信号处理器 (DSP)]，TPS7A85 优异的精度特性（负载和温度范围内的精度为 0.75%）、远程感测、出色的瞬态性能以及软启动功能可确保最优系统性能。

TPS7A85 的多种用途使其成为许多高要求应用会考虑的选择。

器件信息⁽¹⁾

器件型号	封装	封装尺寸 (标称值)
TPS7A85	超薄四方扁平无引线封装 (VQFN) (20)	3.50mm x 3.50mm

(1) 如需了解所有可用封装，请见数据表末尾的可订购产品附录。



TPS7A85

ZHCSEP4A – JANUARY 2016 – REVISED FEBRUARY 2016

www.ti.com.cn

为 RF 组件供电

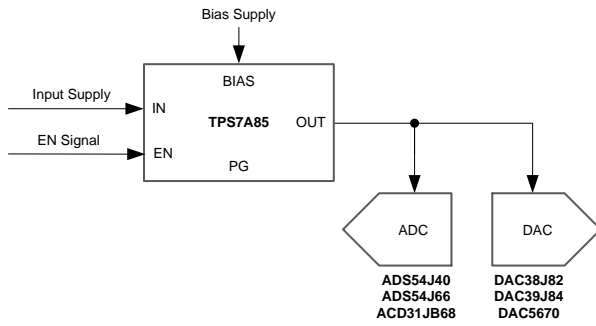

为数字负载供电

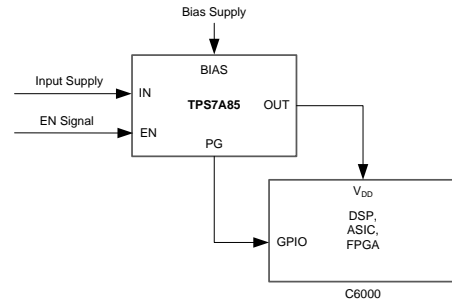

目录

1	特性	1	7.4	Device Functional Modes	20
2	应用	1	8	Application and Implementation	21
3	说明	1	8.1	Application Information	21
4	修订历史记录	3	8.2	Typical Applications	36
5	Pin Configurations and Functions	4	9	Power-Supply Recommendations	38
6	Specifications	5	10	Layout	39
6.1	Absolute Maximum Ratings	5	10.1	Layout Guidelines	39
6.2	ESD Ratings	5	10.2	Layout Example	39
6.3	Recommended Operating Conditions	5	11	器件和文档支持	40
6.4	Thermal Information	6	11.1	器件支持	40
6.5	Electrical Characteristics	6	11.2	文档支持	40
6.6	Typical Characteristics	8	11.3	社区资源	40
7	Detailed Description	16	11.4	商标	41
7.1	Overview	16	11.5	静电放电警告	41
7.2	Functional Block Diagram	17	11.6	Glossary	41
7.3	Feature Description	18	12	机械、封装和可订购信息	41

4 修订历史记录

Changes from Original (January 2016) to Revision A

Page

•	已发布为量产数据	1
---	----------------	----------

5 Pin Configurations and Functions

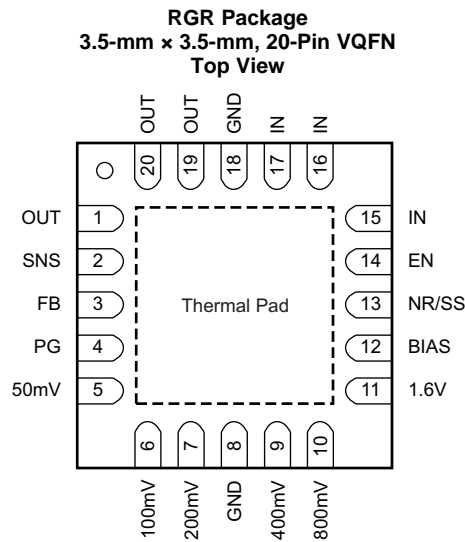

Pin Functions

PIN			DESCRIPTION
NAME	NO.	I/O	
50mV	5	I	ANY-OUT voltage setting pins. Connect these pins to ground, SNS, or leave floating. Connecting these pins to ground increases the output voltage, whereas connecting these pins to SNS increases the resolution of the ANY-OUT network but decreases the range of the network; multiple pins can be simultaneously connected to GND or SNS to select the desired output voltage. Leave these pins floating (open) when not in use. See the ANY-OUT Programmable Output Voltage section for additional details.
100mV	6		
200mV	7		
400mV	9		
800mV	10		
1.6V	11		
BIAS	12	I	BIAS supply voltage. This pin enables the use of low-input voltage, low-output (LILLO) voltage conditions (that is, $V_{IN} = 1.2\text{ V}$, $V_{OUT} = 1\text{ V}$) to reduce power dissipation across the die. The use of a BIAS voltage improves dc and ac performance for $V_{IN} \leq 2.2\text{ V}$. A 10- μF capacitor or larger must be connected between this pin and ground. If not used, this pin must be left floating or tied to ground.
EN	14	I	Enable pin. Driving this pin to logic high enables the device; driving this pin to logic low disables the device. If enable functionality is not required, this pin must be connected to IN. If enable functionality is required, V_{EN} must always be high after V_{IN} is established when a BIAS supply is used. See the Sequencing Requirements section for more details.
FB	3	I	Feedback pin connected to the error amplifier. Although not required, a 10-nF feed-forward capacitor from FB to OUT (as close to the device as possible) is recommended to maximize ac performance. The use of a feed-forward capacitor can disrupt PG (power good) functionality. See the ANY-OUT Programmable Output Voltage and Adjustable Operation sections for more details.
GND	8, 18	—	Ground pin. These pins must be connected to ground, the thermal pad, and each other with a low-impedance connection.
IN	15-17	I	Input supply voltage pins. A 47- μF or larger ceramic capacitor (25 μF or greater of effective capacitance) from IN to ground is recommended to reduce the impedance of the input supply. Place the input capacitor as close to the input as possible. See the Input and Output Capacitor Requirements section for more details.
NR/SS	13	—	Noise-reduction and soft-start pin. Connecting an external capacitor between this pin and ground reduces reference voltage noise and also enables the soft-start function. Although not required, a 10-nF or larger capacitor is recommended to be connected from NR/SS to GND (as close to the pin as possible) to maximize ac performance. See the Noise-Reduction and Soft-Start Capacitor section for more details.
OUT	1, 19, 20	O	Regulated output pins. A 47- μF or larger ceramic capacitor (25 μF or greater of effective capacitance) from OUT to ground is required for stability and must be placed as close to the output as possible. Minimize the impedance from the OUT pin to the load. See the Input and Output Capacitor Requirements section for more details.
PG	4	O	Active-high, power-good pin. An open-drain output indicates when the output voltage reaches 89.3% of the target. The use of a feed-forward capacitor can disrupt PG (power good) functionality. See the Power-Good (PG) Function section for more details.
SNS	2	I	Output voltage sense input pin. This pin connects the internal R_T resistor to the output. Connect this pin to the load side of the output trace only if the ANY-OUT feature is used. If the ANY-OUT feature is not used, leave this pin floating. See the ANY-OUT Programmable Output Voltage and Adjustable Operation sections for more details.
Thermal pad		—	Connect the thermal pad to a large-area ground plane. The thermal pad is internally connected to GND.

6 Specifications

6.1 Absolute Maximum Ratings

over junction temperature range (unless otherwise noted)⁽¹⁾

		MIN	MAX	UNIT
Voltage	IN, BIAS, PG, EN	-0.3	7.0	V
	IN, BIAS, PG, EN (5% duty cycle, pulse duration = 200 μs)	-0.3	7.5	
	SNS, OUT	-0.3	$V_{IN} + 0.3$ ⁽²⁾	
	NR/SS, FB	-0.3	3.6	
	50mV, 100mV, 200mV, 400mV, 800mV, 1.6V	-0.3	$V_{OUT} + 0.3$	
Current	OUT	Internally limited		A
	PG (sink current into device)	5		mA
Operating junction temperature, T_J		-55	150	°C
Storage temperature, T_{stg}		-55	150	°C

- (1) Stresses beyond those listed under *Absolute Maximum Ratings* may cause permanent damage to the device. These are stress ratings only, which do not imply functional operation of the device at these or any other conditions beyond those indicated under *Recommended Operating Conditions*. Exposure to absolute-maximum-rated conditions for extended periods may affect device reliability.
- (2) The absolute maximum rating is $V_{IN} + 0.3$ V or 7.0 V, whichever is smaller.

6.2 ESD Ratings

		VALUE	UNIT
$V_{(ESD)}$ Electrostatic discharge	Human-body model (HBM), per ANSI/ESDA/JEDEC JS-001 ⁽¹⁾	±2000	V
	Charged-device model (CDM), per JEDEC specification JESD22-C101 ⁽²⁾	±500	

- (1) JEDEC document JEP155 states that 500-V HBM allows safe manufacturing with a standard ESD control process.
- (2) JEDEC document JEP157 states that 250-V CDM allows safe manufacturing with a standard ESD control process.

6.3 Recommended Operating Conditions

over junction temperature range (unless otherwise noted)

		MIN	NOM	MAX	UNIT
V_{IN}	Input supply voltage range	1.1		6.5	V
V_{BIAS}	Bias supply voltage range ⁽¹⁾	3.0		6.5	V
V_{OUT}	Output voltage range ⁽²⁾	0.8		5	V
V_{EN}	Enable voltage range	0		V_{IN}	V
I_{OUT}	Output current	0		4	A
C_{IN}	Input capacitor	10	47		μF
C_{OUT}	Output capacitor	47	47 10 10 ⁽³⁾		μF
R_{PG}	Power-good pullup resistance	10		100	kΩ
$C_{NR/SS}$	NR/SS capacitor		10		nF
C_{FF}	Feed-forward capacitor		10		nF
R_1	Top resistor value in feedback network for adjustable operation		12.1 ⁽⁴⁾		kΩ
R_2	Bottom resistor value in feedback network for adjustable operation			160 ⁽⁵⁾	kΩ
T_J	Operating junction temperature	-40		125	°C

- (1) BIAS supply is required when the V_{IN} supply is below 1.4 V. Conversely, no BIAS supply is required when the V_{IN} supply is higher than or equal to 1.4 V. A BIAS supply helps improve dc and ac performance for $V_{IN} \leq 2.2$ V.
- (2) This output voltage range does not include device accuracy or accuracy of the feedback resistors.
- (3) The recommended output capacitors are selected to optimize PSRR for the frequency range of 400 kHz to 700 kHz. This frequency range is a typical value for dc-dc supplies.
- (4) The 12.1-kΩ resistor is selected to optimize PSRR and noise by matching the internal R_1 value.
- (5) The upper limit for the R_2 resistor is to ensure accuracy by making the current through the feedback network much larger than the leakage current into the feedback node.

6.4 Thermal Information

THERMAL METRIC ⁽¹⁾		TPS7A85	UNIT
		RGR (VQFN)	
		20 PINS	
R _{θJA}	Junction-to-ambient thermal resistance	35.4	°C/W
R _{θJC(top)}	Junction-to-case (top) thermal resistance	47.6	°C/W
R _{θJB}	Junction-to-board thermal resistance	12.3	°C/W
ψ _{JT}	Junction-to-top characterization parameter	0.5	°C/W
ψ _{JB}	Junction-to-board characterization parameter	12.4	°C/W
R _{θJC(bot)}	Junction-to-case (bottom) thermal resistance	1.0	°C/W

(1) For more information about traditional and new thermal metrics, see the *IC Package Thermal Metrics* application report, [SPRA953](#).

6.5 Electrical Characteristics

Over operating junction temperature range ($T_J = -40^\circ\text{C}$ to $+125^\circ\text{C}$), $V_{IN} = 1.4\text{ V}$ or $V_{IN} = V_{OUT(nom)} + 0.5\text{ V}$ (whichever is greater), $V_{BIAS} = \text{open}$, $V_{OUT(nom)} = 0.8\text{ V}$ ⁽¹⁾, OUT connected to $50\ \Omega$ to GND⁽²⁾, $V_{EN} = 1.1\text{ V}$, $C_{IN} = 10\ \mu\text{F}$, $C_{OUT} = 47\ \mu\text{F}$, $C_{NR/SS}$ without C_{FF} , and PG pin pulled up to V_{IN} with $100\text{ k}\Omega$, unless otherwise noted. Typical values are at $T_J = 25^\circ\text{C}$.

PARAMETER		TEST CONDITIONS	MIN	TYP	MAX	UNIT	
V _{IN}	Input supply voltage range ⁽³⁾		1.1		6.5	V	
V _{BIAS}	Bias supply voltage range ⁽³⁾	V _{IN} = 1.1 V	3.0		6.5	V	
V _{FB}	Feedback voltage			0.8		V	
V _{NR/SS}	NR/SS pin voltage			0.8		V	
V _{UVLO1(IN)}	Input supply UVLO with BIAS	V _{IN} rising with V _{BIAS} = 3.0 V		1.02	1.085	V	
V _{HYS1(IN)}	V _{UVLO1(IN)} hysteresis	V _{BIAS} = 3.0 V		320		mV	
V _{UVLO2(IN)}	Input supply UVLO without BIAS	V _{IN} rising		1.31	1.39	V	
V _{HYS2(IN)}	V _{UVLO2(IN)} hysteresis			253		mV	
V _{UVLO(BIAS)}	Bias supply UVLO	V _{BIAS} rising, V _{IN} = 1.1 V		2.83	2.9	V	
V _{HYS(BIAS)}	V _{UVLO(BIAS)} hysteresis	V _{IN} = 1.1 V		290		mV	
V _{OUT}	Output voltage	Range	Using the ANY-OUT pins		0.8 – 1.0%	3.95 + 1.0%	V
			Using external resistors ⁽⁴⁾		0.8 – 1.0%	5.0 + 1.0%	
		Accuracy ⁽⁴⁾⁽⁵⁾	0.8 V ≤ V _{OUT} ≤ 5 V, 5 mA ≤ I _{OUT} ≤ 4 A, over V _{IN}		–1.0%		1.0%
	Accuracy with BIAS	V _{IN} = 1.1 V, 5 mA ≤ I _{OUT} ≤ 4 A, 3.0 V ≤ V _{BIAS} ≤ 6.5 V		–0.75%		0.75%	
ΔV _{OUT} /ΔV _{IN}	Line regulation	I _{OUT} = 5 mA, 1.4 V ≤ V _{IN} ≤ 6.5 V		0.0035		mV/V	
ΔV _{OUT} /ΔI _{OUT}	Load regulation	5 mA ≤ I _{OUT} ≤ 4 A, 3.0 V ≤ V _{BIAS} ≤ 6.5 V, V _{IN} = 1.1 V		0.07		mV/A	
		5 mA ≤ I _{OUT} ≤ 4 A		0.08			
		5 mA ≤ I _{OUT} ≤ 4 A, V _{OUT} = 5.0 V		0.4			
V _{DO}	Dropout voltage	V _{IN} = 1.4 V, I _{OUT} = 4 A, V _{FB} = 0.8 V – 3%		215	320	mV	
		V _{IN} = 5.5 V, I _{OUT} = 4 A, V _{FB} = 0.8 V – 3%		325	500		
		V _{IN} = 1.1 V, V _{BIAS} = 5.0 V, I _{OUT} = 4 A, V _{FB} = 0.8 V – 3%		150	240		
I _{LIM}	Output current limit	V _{OUT} forced at 0.9 × V _{OUT(nom)} , V _{IN} = V _{OUT(nom)} + 0.4 V	4.7	5.2	5.7	A	
I _{SC}	Short-circuit current limit	R _{LOAD} = 20 mΩ		1.0		A	
I _{GND}	GND pin current	V _{IN} = 6.5 V, I _{OUT} = 5 mA		2.8	4.0	mA	
		V _{IN} = 1.4 V, I _{OUT} = 4 A		4.8	6.0		
		Shutdown, PG = open, V _{IN} = 6.5 V, V _{EN} = 0.5 V				25	μA

- (1) V_{OUT(nom)} is the calculated V_{OUT} target value from the ANY-OUT in a fixed configuration. In an adjustable configuration, V_{OUT(nom)} is the expected V_{OUT} value set by the external feedback resistors.
- (2) This 50-Ω load is disconnected when the test conditions specify an I_{OUT} value.
- (3) BIAS supply is required when the V_{IN} supply is below 1.4 V. Conversely, no BIAS supply is required when the V_{IN} supply is higher than or equal to 1.4 V. A BIAS supply helps improve dc and ac performance for V_{IN} ≤ 2.2 V.
- (4) When the device is connected to external feedback resistors at the FB pin, external resistor tolerances are not included.
- (5) The device is not tested under conditions where V_{IN} > V_{OUT} + 1.25 V and I_{OUT} = 4 A, because the power dissipation is higher than the maximum rating of the package.

Electrical Characteristics (continued)

Over operating junction temperature range ($T_J = -40^\circ\text{C}$ to $+125^\circ\text{C}$), $V_{IN} = 1.4\text{ V}$ or $V_{IN} = V_{OUT(nom)} + 0.5\text{ V}$ (whichever is greater), $V_{BIAS} = \text{open}$, $V_{OUT(nom)} = 0.8\text{ V}^{(1)}$, OUT connected to $50\ \Omega$ to GND⁽²⁾, $V_{EN} = 1.1\text{ V}$, $C_{IN} = 10\ \mu\text{F}$, $C_{OUT} = 47\ \mu\text{F}$, $C_{NR/SS}$ without C_{FF} , and PG pin pulled up to V_{IN} with $100\text{ k}\Omega$, unless otherwise noted. Typical values are at $T_J = 25^\circ\text{C}$.

PARAMETER		TEST CONDITIONS	MIN	TYP	MAX	UNIT
I_{EN}	EN pin current	$V_{IN} = 6.5\text{ V}$, $V_{EN} = 0\text{ V}$ and 6.5 V	-0.1		0.1	μA
I_{BIAS}	BIAS pin current	$V_{IN} = 1.1\text{ V}$, $V_{BIAS} = 6.5\text{ V}$, $V_{OUT(nom)} = 0.8\text{ V}$, $I_{OUT} = 4\text{ A}$		2.3	3.5	mA
$V_{IL(EN)}$	EN pin high-level input voltage (enable device)		0		0.5	V
$V_{IH(EN)}$	EN pin low-level input voltage (disable device)		1.1		6.5	V
$V_{IT(PG)}$	PG pin threshold	For falling V_{OUT}	$82\% \times V_{OUT}$	$88.3\% \times V_{OUT}$	$93\% \times V_{OUT}$	V
$V_{HYS(PG)}$	PG pin hysteresis	For rising V_{OUT}		$1\% \times V_{OUT}$		V
$V_{OL(PG)}$	PG pin low-level output voltage	$V_{OUT} < V_{IT(PG)}$, $I_{PG} = -1\text{ mA}$ (current sunk into pin)			0.4	V
$I_{kg(PG)}$	PG pin leakage current	$V_{OUT} > V_{IT(PG)}$, $V_{PG} = 6.5\text{ V}$			1	μA
$I_{NR/SS}$	NR/SS pin charging current	$V_{NR/SS} = \text{GND}$, $V_{IN} = 6.5\text{ V}$	4.0	6.2	9.0	μA
I_{FB}	FB pin leakage current	$V_{IN} = 6.5\text{ V}$	-100		100	nA
PSRR	Power-supply ripple rejection	$V_{IN} - V_{OUT} = 0.5\text{ V}$, $I_{OUT} = 4\text{ A}$, $C_{NR/SS} = 100\text{ nF}$, $C_{FF} = 10\text{ nF}$, $C_{OUT} = 47\ \mu\text{F} \parallel 10\ \mu\text{F} \parallel 10\ \mu\text{F}$	$f = 10\text{ kHz}$, $V_{OUT} = 0.8\text{ V}$, $V_{BIAS} = 5.0\text{ V}$	42		dB
			$f = 500\text{ kHz}$, $V_{OUT} = 0.8\text{ V}$, $V_{BIAS} = 5.0\text{ V}$	39		
			$f = 10\text{ kHz}$, $V_{OUT} = 3.3\text{ V}$	40		
			$f = 500\text{ kHz}$, $V_{OUT} = 3.3\text{ V}$	25		
V_n	Output noise voltage	BW = 10 Hz to 100 kHz, $V_{IN} = 1.2\text{ V}$, $V_{OUT} = 0.8\text{ V}$, $V_{BIAS} = 5.0\text{ V}$, $I_{OUT} = 4\text{ A}$, $C_{NR/SS} = 100\text{ nF}$, $C_{FF} = 10\text{ nF}$, $C_{OUT} = 47\ \mu\text{F} \parallel 10\ \mu\text{F} \parallel 10\ \mu\text{F}$		4.4		μV_{RMS}
			BW = 10 Hz to 100 kHz, $V_{OUT} = 5.0\text{ V}$, $I_{OUT} = 4\text{ A}$, $C_{NR/SS} = 100\text{ nF}$, $C_{FF} = 10\text{ nF}$, $C_{OUT} = 47\ \mu\text{F} \parallel 10\ \mu\text{F} \parallel 10\ \mu\text{F}$		8.4	
T_{sd}	Thermal shutdown temperature	Shutdown, temperature increasing		160		$^\circ\text{C}$
		Reset, temperature decreasing		140		
T_J	Operating junction temperature		-40		125	$^\circ\text{C}$

6.6 Typical Characteristics

at $T_A = 25^\circ\text{C}$, $V_{IN} = 1.4\text{ V}$ or $V_{IN} = V_{OUT(NOM)} + 0.5\text{ V}$ (whichever is greater), $V_{BIAS} = \text{open}$, $V_{OUT(NOM)} = 0.8\text{ V}$, $V_{EN} = 1.1\text{ V}$, $C_{OUT} = 47\text{ }\mu\text{F}$, $C_{NR/SS} = 0\text{ nF}$, $C_{FF} = 0\text{ nF}$, and PG pin pulled up to V_{IN} with $100\text{ k}\Omega$ (unless otherwise noted)

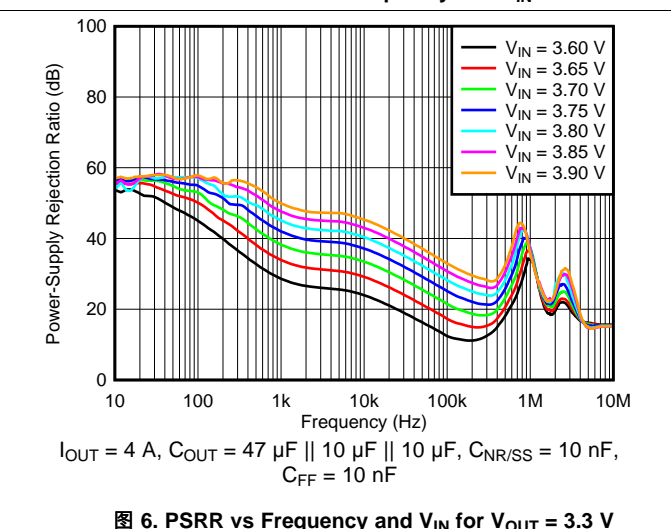
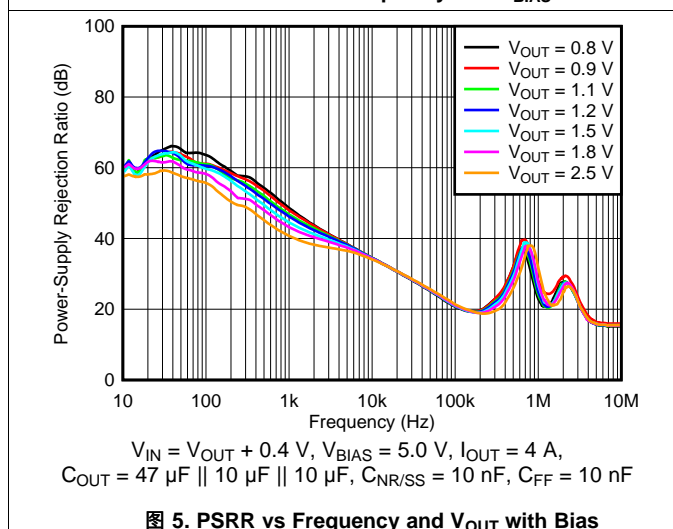
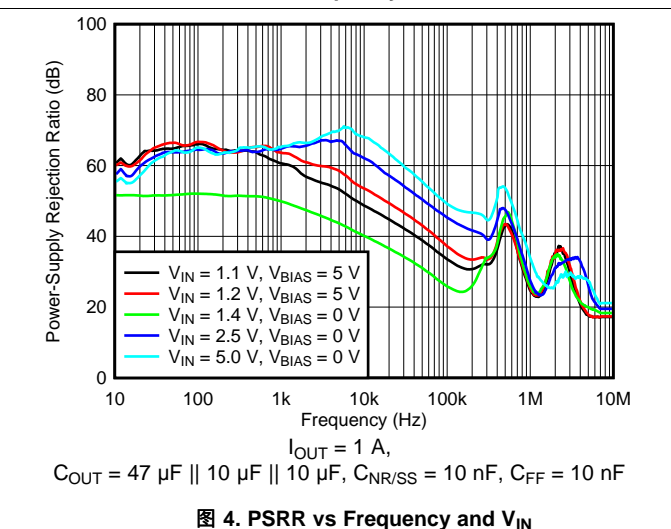
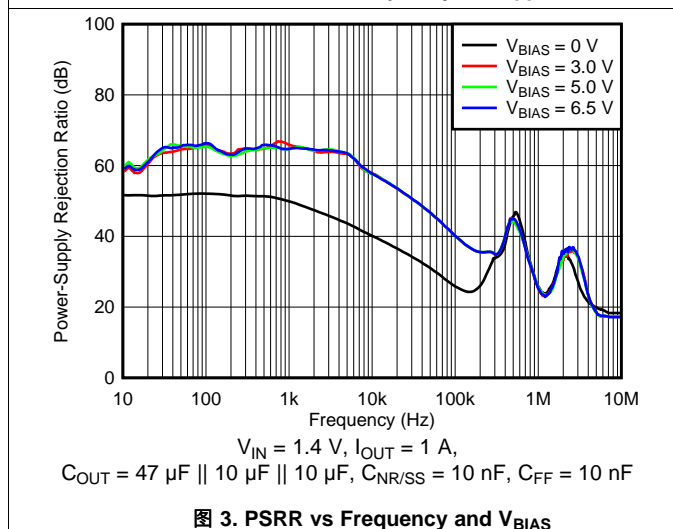
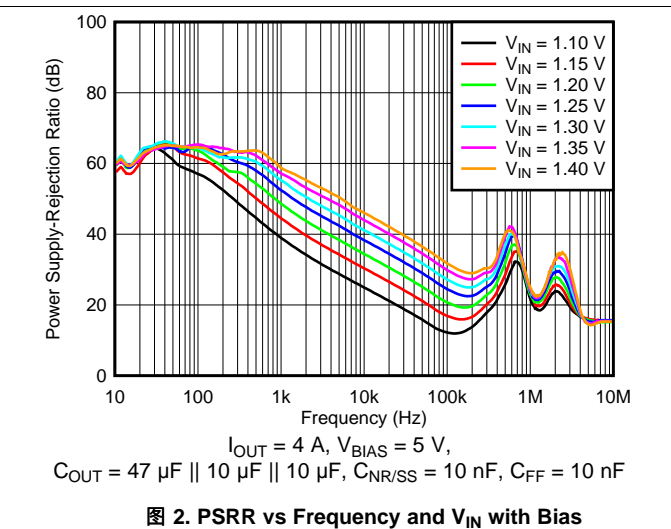
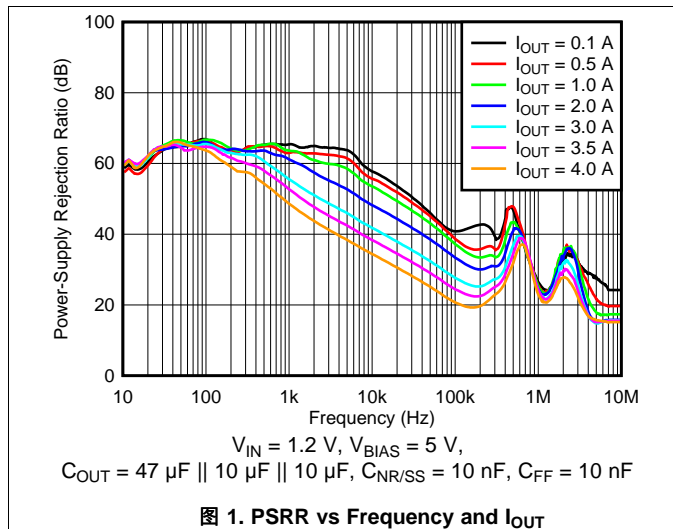

Typical Characteristics (接下页)

at $T_A = 25^\circ\text{C}$, $V_{IN} = 1.4\text{ V}$ or $V_{IN} = V_{OUT(NOM)} + 0.5\text{ V}$ (whichever is greater), $V_{BIAS} = \text{open}$, $V_{OUT(NOM)} = 0.8\text{ V}$, $V_{EN} = 1.1\text{ V}$, $C_{OUT} = 47\text{ }\mu\text{F}$, $C_{NR/SS} = 0\text{ nF}$, $C_{FF} = 0\text{ nF}$, and PG pin pulled up to V_{IN} with $100\text{ k}\Omega$ (unless otherwise noted)

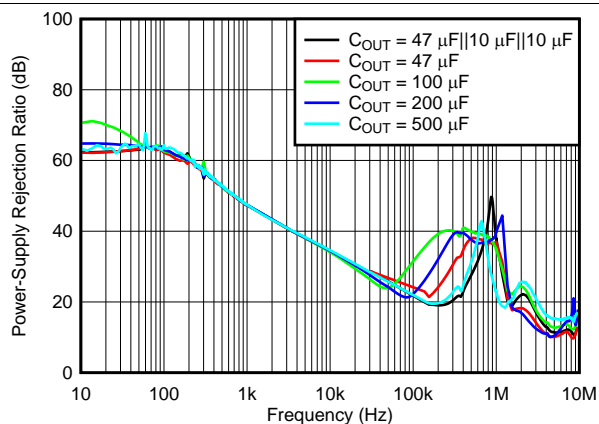

$V_{IN} = 5.6\text{ V}$, $C_{OUT} = 47\text{ }\mu\text{F} \parallel 10\text{ }\mu\text{F} \parallel 10\text{ }\mu\text{F}$,
 $C_{NR/SS} = 10\text{ nF}$, $C_{FF} = 10\text{ nF}$

图 7. PSRR vs Frequency and C_{OUT}

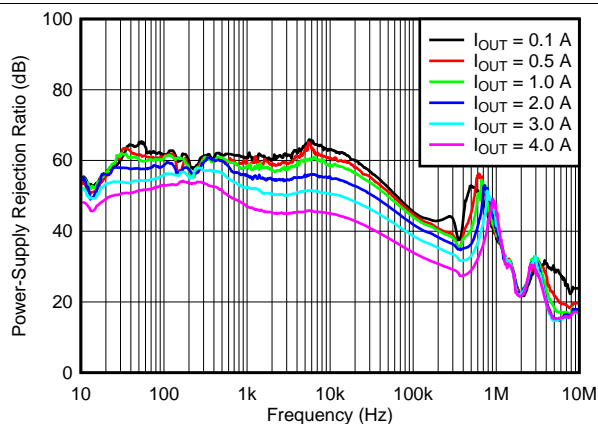

$V_{IN} = V_{OUT} + 0.4\text{ V}$, $V_{OUT} = 1\text{ V}$, $I_{OUT} = 4\text{ A}$,
 $C_{OUT} = 47\text{ }\mu\text{F} \parallel 10\text{ }\mu\text{F} \parallel 10\text{ }\mu\text{F}$, $C_{NR/SS} = 10\text{ nF}$, $C_{FF} = 10\text{ nF}$

图 8. PSRR vs Frequency and I_{OUT} for $V_{OUT} = 5.0\text{ V}$

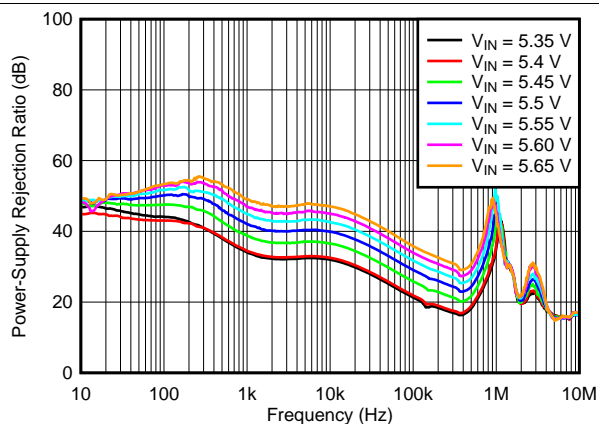

$I_{OUT} = 4\text{ A}$, $C_{OUT} = 47\text{ }\mu\text{F} \parallel 10\text{ }\mu\text{F} \parallel 10\text{ }\mu\text{F}$, $C_{NR/SS} = 10\text{ nF}$,
 $C_{FF} = 10\text{ nF}$

图 9. PSRR vs Frequency and V_{IN} for $V_{OUT} = 5.0\text{ V}$

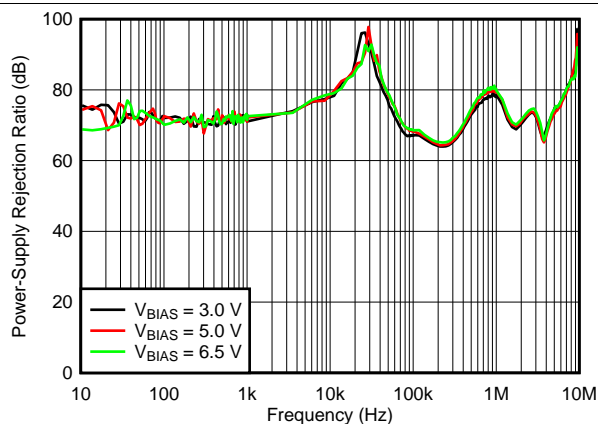

$V_{IN} = V_{OUT} + 0.4\text{ V}$, $V_{OUT} = 1\text{ V}$, $I_{OUT} = 4\text{ A}$,
 $C_{OUT} = 47\text{ }\mu\text{F} \parallel 10\text{ }\mu\text{F} \parallel 10\text{ }\mu\text{F}$, $C_{NR/SS} = 10\text{ nF}$, $C_{FF} = 10\text{ nF}$

图 10. V_{BIAS} PSRR vs Frequency

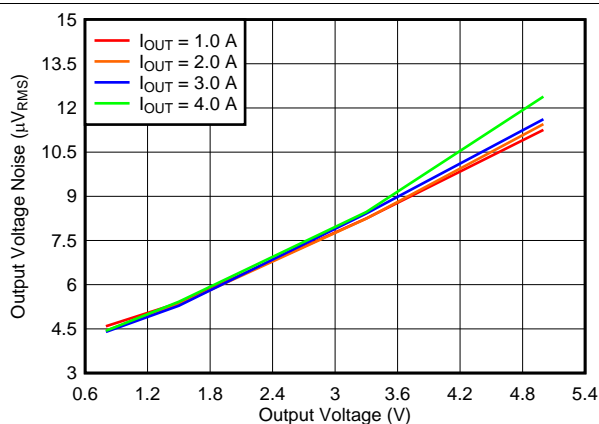

$V_{IN} = V_{OUT} + 0.4\text{ V}$ and $V_{BIAS} = 5\text{ V}$ for $V_{OUT} \leq 2.2\text{ V}$,
 $C_{OUT} = 47\text{ }\mu\text{F} \parallel 10\text{ }\mu\text{F} \parallel 10\text{ }\mu\text{F}$, $C_{NR/SS} = 10\text{ nF}$, $C_{FF} = 10\text{ nF}$

图 11. Output Voltage Noise vs Output Voltage

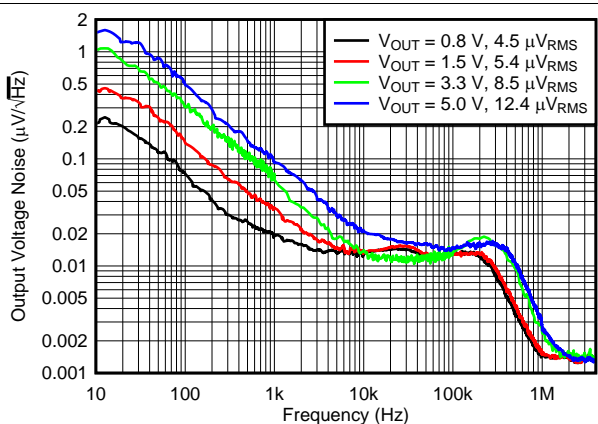

$V_{IN} = V_{OUT} + 0.4\text{ V}$ and $V_{BIAS} = 5\text{ V}$ for $V_{OUT} \leq 2.2\text{ V}$, $I_{OUT} = 4\text{ A}$,
 $C_{OUT} = 47\text{ }\mu\text{F} \parallel 10\text{ }\mu\text{F} \parallel 10\text{ }\mu\text{F}$, $C_{NR/SS} = 10\text{ nF}$, $C_{FF} = 10\text{ nF}$

图 12. Output Noise vs Frequency and V_{OUT}

Typical Characteristics (接下页)

at $T_A = 25^\circ\text{C}$, $V_{IN} = 1.4\text{ V}$ or $V_{IN} = V_{OUT(NOM)} + 0.5\text{ V}$ (whichever is greater), $V_{BIAS} = \text{open}$, $V_{OUT(NOM)} = 0.8\text{ V}$, $V_{EN} = 1.1\text{ V}$, $C_{OUT} = 47\text{ }\mu\text{F}$, $C_{NR/SS} = 0\text{ nF}$, $C_{FF} = 0\text{ nF}$, and PG pin pulled up to V_{IN} with $100\text{ k}\Omega$ (unless otherwise noted)

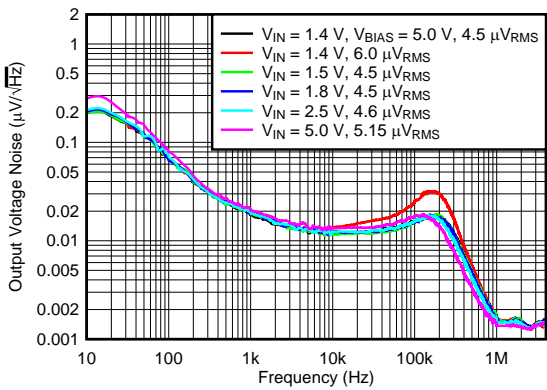

$I_{OUT} = 1\text{ A}$, $C_{OUT} = 47\text{ }\mu\text{F} \parallel 10\text{ }\mu\text{F} \parallel 10\text{ }\mu\text{F}$, $C_{NR/SS} = 10\text{ nF}$, $C_{FF} = 10\text{ nF}$

图 13. Output Noise vs Frequency and V_{IN}

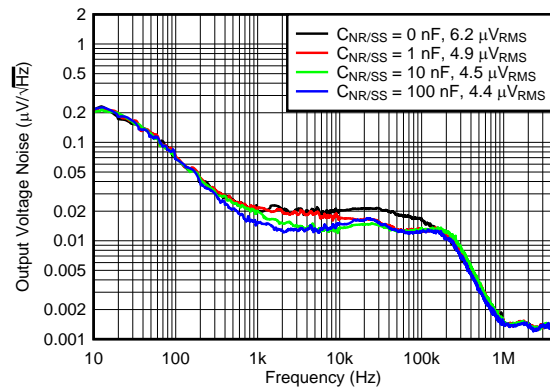

$V_{IN} = V_{OUT} + 0.4\text{ V}$, $V_{BIAS} = 5\text{ V}$, $I_{OUT} = 4\text{ A}$, $C_{OUT} = 47\text{ }\mu\text{F} \parallel 10\text{ }\mu\text{F} \parallel 10\text{ }\mu\text{F}$, $C_{FF} = 10\text{ nF}$

图 14. Output Noise vs Frequency and $C_{NR/SS}$

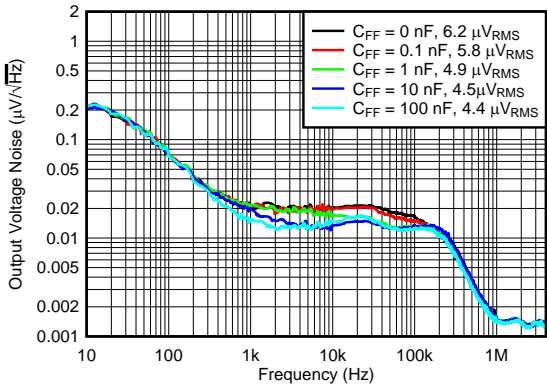

$V_{IN} = V_{OUT} + 0.4\text{ V}$, $V_{BIAS} = 5\text{ V}$, $I_{OUT} = 4\text{ A}$, $C_{OUT} = 47\text{ }\mu\text{F} \parallel 10\text{ }\mu\text{F} \parallel 10\text{ }\mu\text{F}$, $C_{NR/SS} = 10\text{ nF}$

图 15. Output Noise vs Frequency and C_{FF}

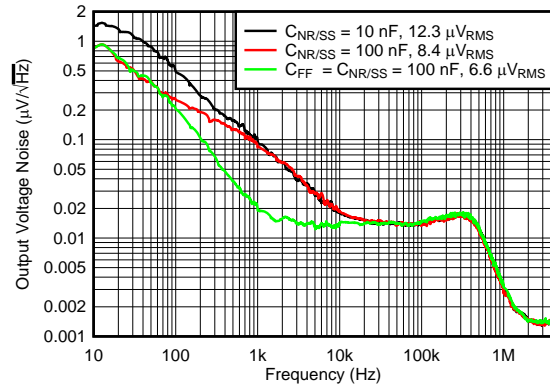

$V_{IN} = 5.6\text{ V}$, $I_{OUT} = 4\text{ A}$, $C_{OUT} = 47\text{ }\mu\text{F} \parallel 10\text{ }\mu\text{F} \parallel 10\text{ }\mu\text{F}$, $C_{FF} = 10\text{ nF}$

图 16. Output Noise at 5.0-V Output vs $C_{NR/SS}$ and C_{FF}

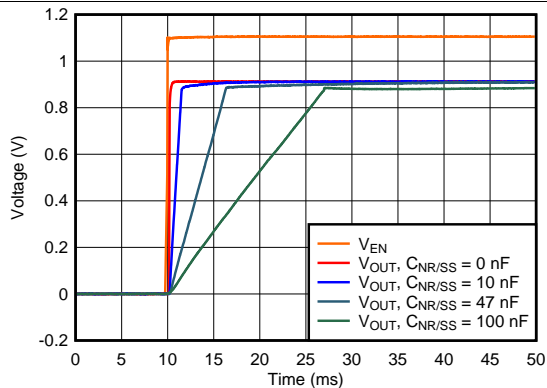

$V_{IN} = 1.2\text{ V}$, $V_{OUT} = 0.9\text{ V}$, $V_{BIAS} = 5.0\text{ V}$, $I_{OUT} = 4\text{ A}$, $C_{OUT} = 47\text{ }\mu\text{F} \parallel 10\text{ }\mu\text{F} \parallel 10\text{ }\mu\text{F}$, $C_{FF} = 10\text{ nF}$

图 17. Start-Up Waveform vs Time and $C_{NR/SS}$

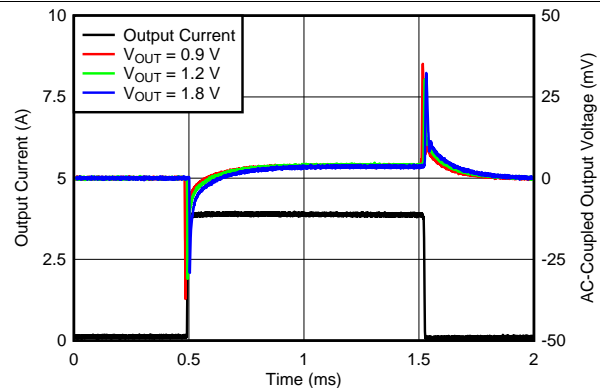

$V_{IN} = V_{OUT} + 0.3\text{ V}$, $V_{BIAS} = 5\text{ V}$, $I_{OUT, DC} = 100\text{ mA}$, slew rate = $1\text{ A}/\mu\text{s}$, $C_{NR/SS} = C_{FF} = 10\text{ nF}$, $C_{OUT} = 47\text{ }\mu\text{F} \parallel 10\text{ }\mu\text{F} \parallel 10\text{ }\mu\text{F}$

图 18. Load Transient Waveform vs Time and V_{OUT} with Bias

Typical Characteristics (接下页)

at $T_A = 25^\circ\text{C}$, $V_{IN} = 1.4\text{ V}$ or $V_{IN} = V_{OUT(NOM)} + 0.5\text{ V}$ (whichever is greater), $V_{BIAS} = \text{open}$, $V_{OUT(NOM)} = 0.8\text{ V}$, $V_{EN} = 1.1\text{ V}$, $C_{OUT} = 47\text{ }\mu\text{F}$, $C_{NR/SS} = 0\text{ nF}$, $C_{FF} = 0\text{ nF}$, and PG pin pulled up to V_{IN} with $100\text{ k}\Omega$ (unless otherwise noted)

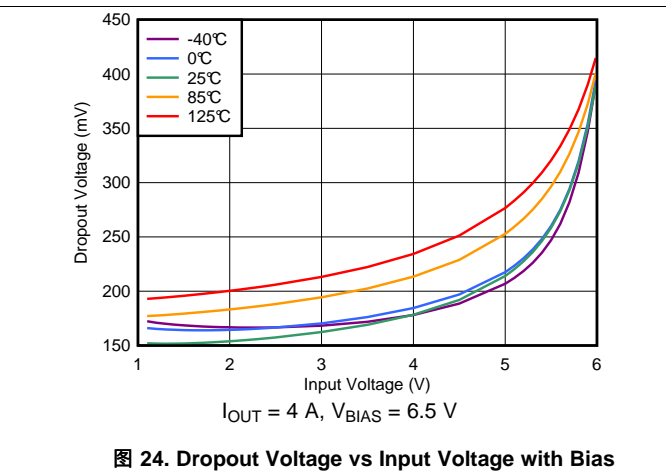
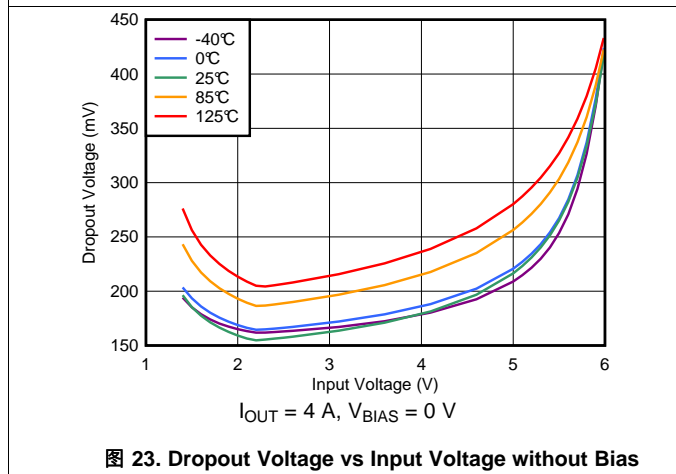
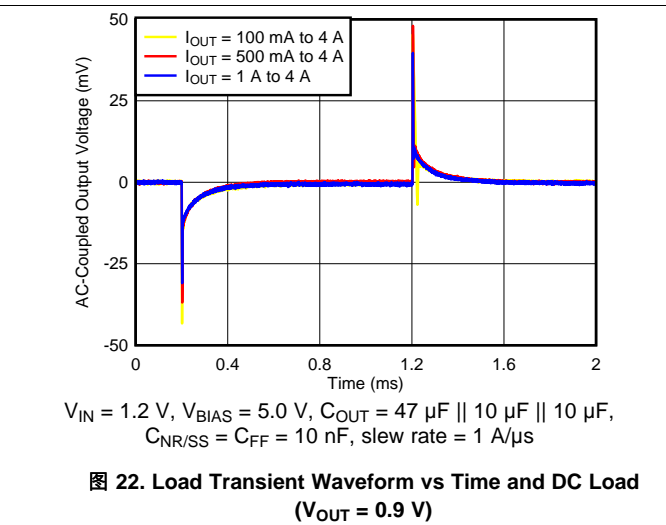
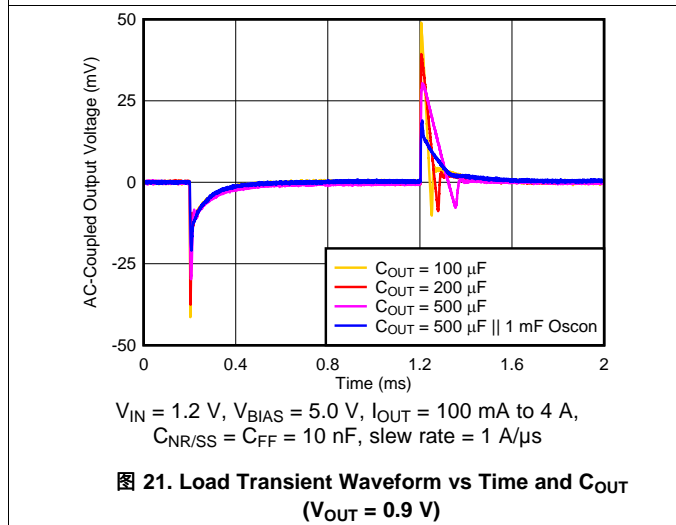
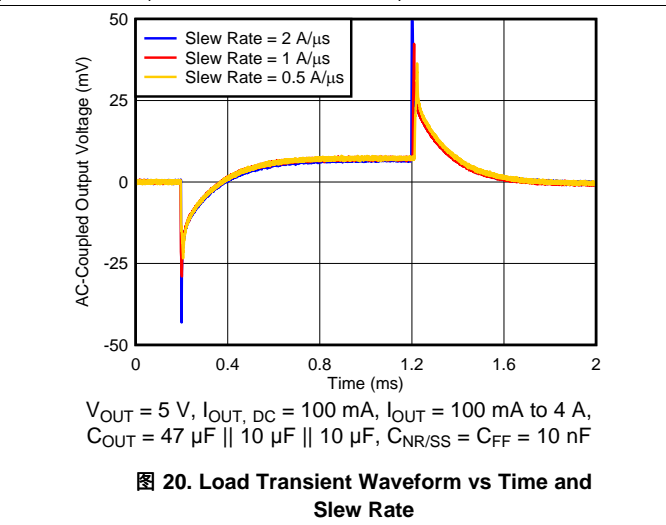
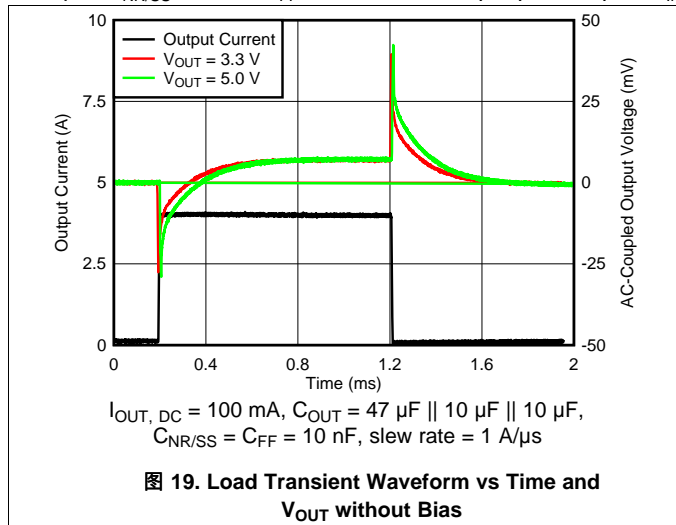

Typical Characteristics (接下页)

at $T_A = 25^\circ\text{C}$, $V_{IN} = 1.4\text{ V}$ or $V_{IN} = V_{OUT(NOM)} + 0.5\text{ V}$ (whichever is greater), $V_{BIAS} = \text{open}$, $V_{OUT(NOM)} = 0.8\text{ V}$, $V_{EN} = 1.1\text{ V}$, $C_{OUT} = 47\text{ }\mu\text{F}$, $C_{NR/SS} = 0\text{ nF}$, $C_{FF} = 0\text{ nF}$, and PG pin pulled up to V_{IN} with $100\text{ k}\Omega$ (unless otherwise noted)



图 25. Dropout Voltage vs Output Current without Bias



图 26. Dropout Voltage vs Output Current with Bias

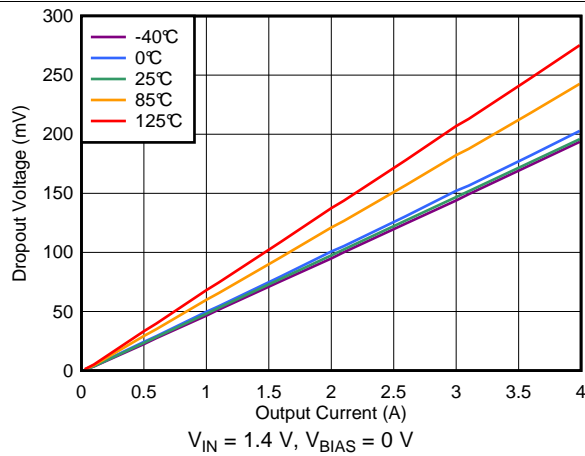

图 27. Dropout Voltage vs Output Current (High V_{IN})

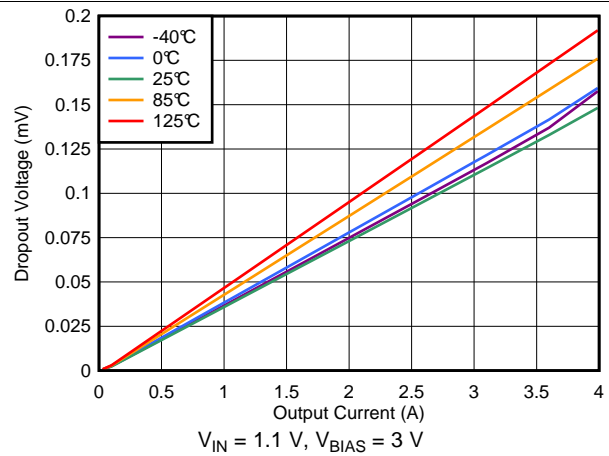

图 28. Load Regulation vs Output Voltage

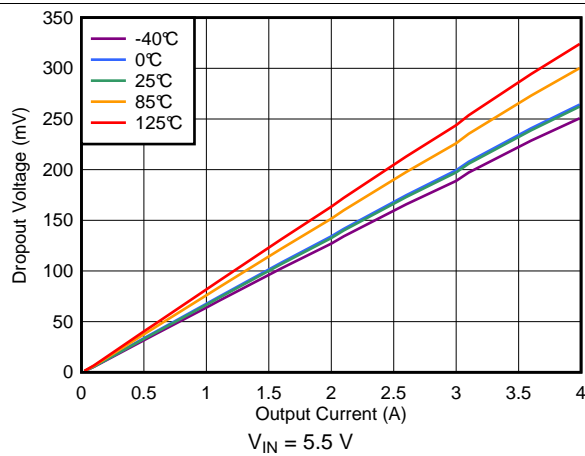

图 29. Load Regulation (0.8-V Output)

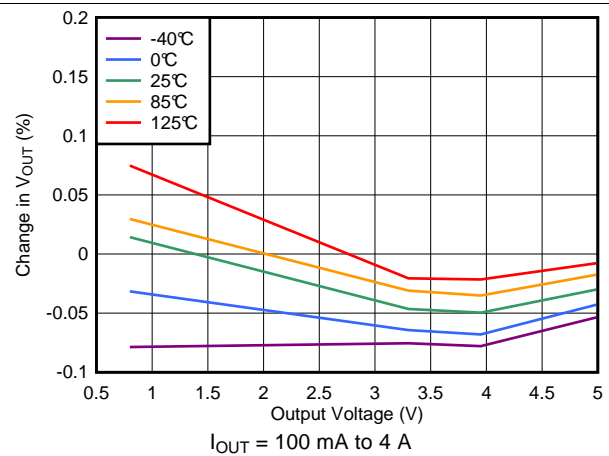

图 30. Load Regulation (3.3-V Output)

Typical Characteristics (接下页)

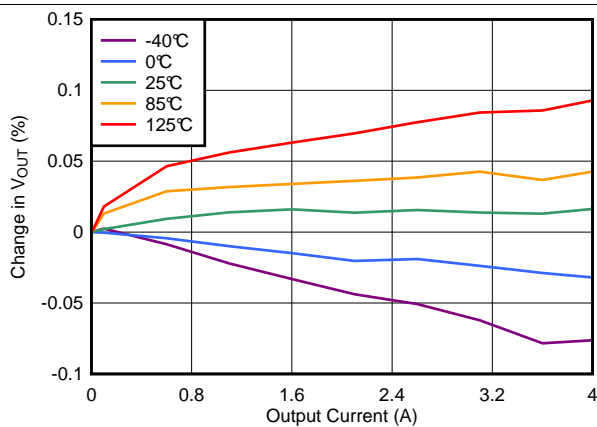
at $T_A = 25^\circ\text{C}$, $V_{IN} = 1.4\text{ V}$ or $V_{IN} = V_{OUT(NOM)} + 0.5\text{ V}$ (whichever is greater), $V_{BIAS} = \text{open}$, $V_{OUT(NOM)} = 0.8\text{ V}$, $V_{EN} = 1.1\text{ V}$, $C_{OUT} = 47\text{ }\mu\text{F}$, $C_{NR/SS} = 0\text{ nF}$, $C_{FF} = 0\text{ nF}$, and PG pin pulled up to V_{IN} with $100\text{ k}\Omega$ (unless otherwise noted)

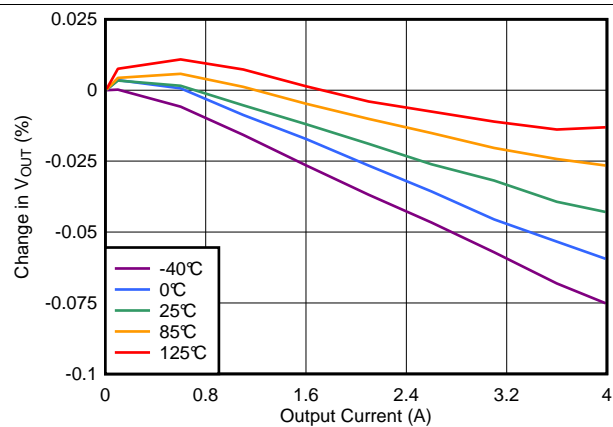
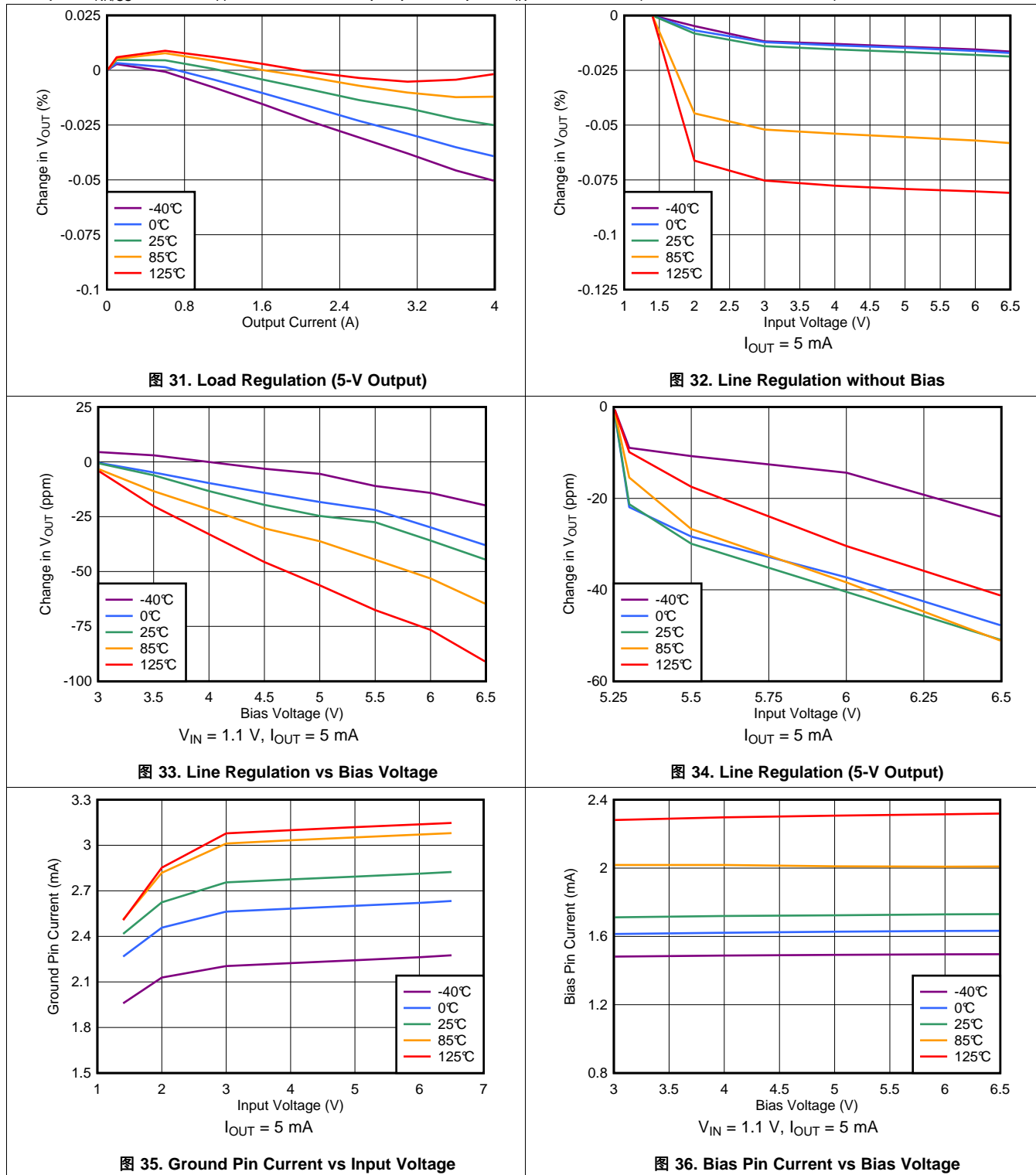

Typical Characteristics (接下页)

at $T_A = 25^\circ\text{C}$, $V_{IN} = 1.4\text{ V}$ or $V_{IN} = V_{OUT(NOM)} + 0.5\text{ V}$ (whichever is greater), $V_{BIAS} = \text{open}$, $V_{OUT(NOM)} = 0.8\text{ V}$, $V_{EN} = 1.1\text{ V}$, $C_{OUT} = 47\text{ }\mu\text{F}$, $C_{NR/SS} = 0\text{ nF}$, $C_{FF} = 0\text{ nF}$, and PG pin pulled up to V_{IN} with $100\text{ k}\Omega$ (unless otherwise noted)



图 37. Shutdown Current vs Input Voltage



图 38. Shutdown Current vs Bias Voltage

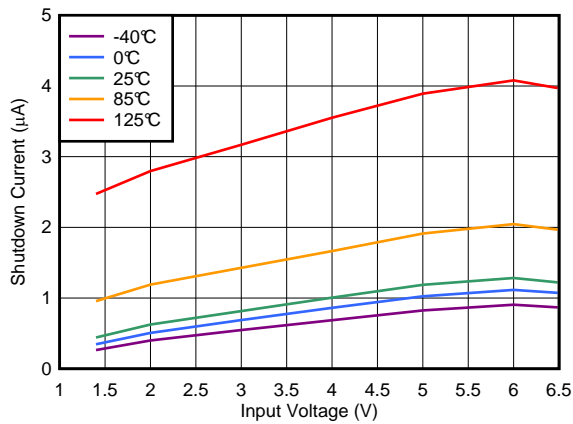

图 39. NR/SS Charging Current vs Input Voltage

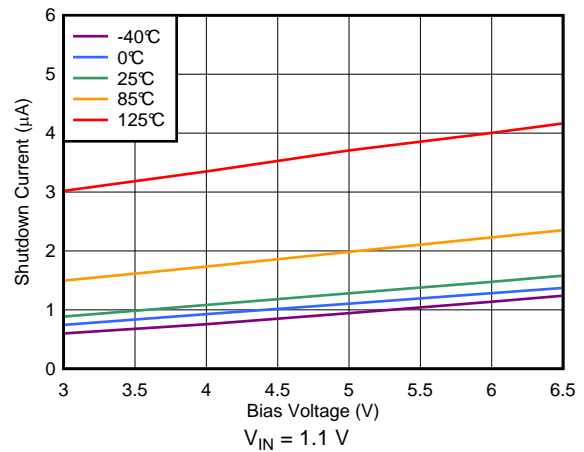

图 40. V_{IN} UVLO vs Temperature

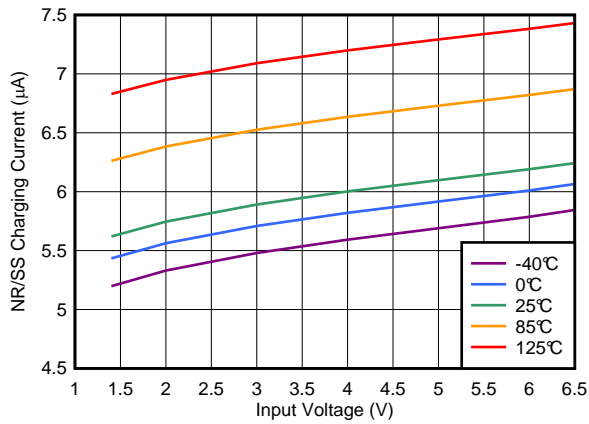

图 41. V_{BIAS} UVLO vs Temperature

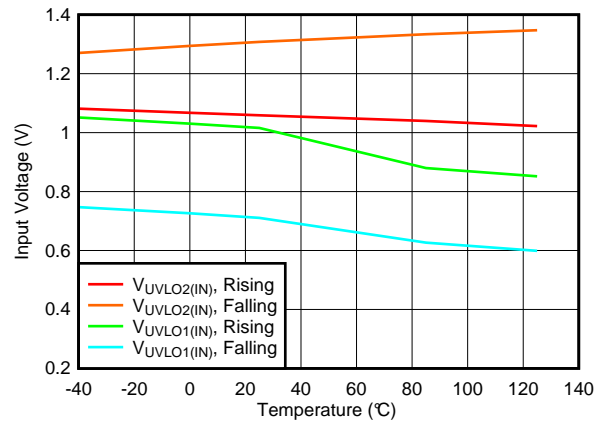

图 42. Enable Threshold vs Temperature

Typical Characteristics (接下页)

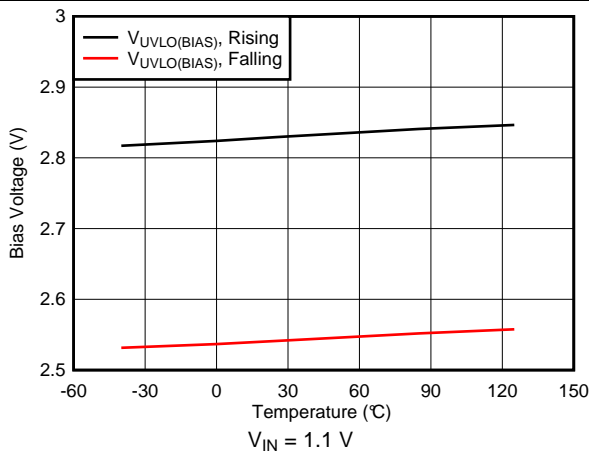
at $T_A = 25^\circ\text{C}$, $V_{IN} = 1.4\text{ V}$ or $V_{IN} = V_{OUT(NOM)} + 0.5\text{ V}$ (whichever is greater), $V_{BIAS} = \text{open}$, $V_{OUT(NOM)} = 0.8\text{ V}$, $V_{EN} = 1.1\text{ V}$, $C_{OUT} = 47\text{ }\mu\text{F}$, $C_{NR/SS} = 0\text{ nF}$, $C_{FF} = 0\text{ nF}$, and PG pin pulled up to V_{IN} with $100\text{ k}\Omega$ (unless otherwise noted)

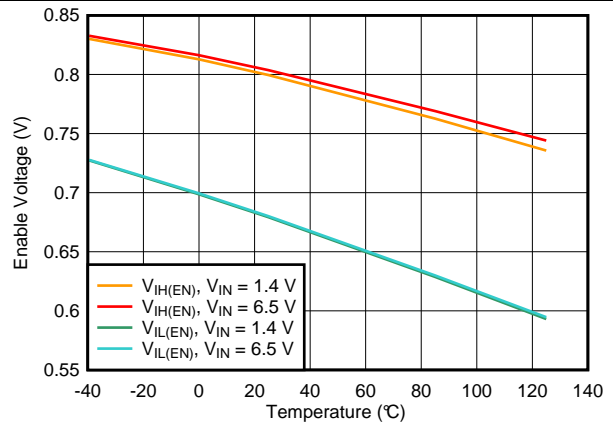

图 43. PG Voltage vs PG Current Sink



图 44. PG Voltage vs PG Current Sink

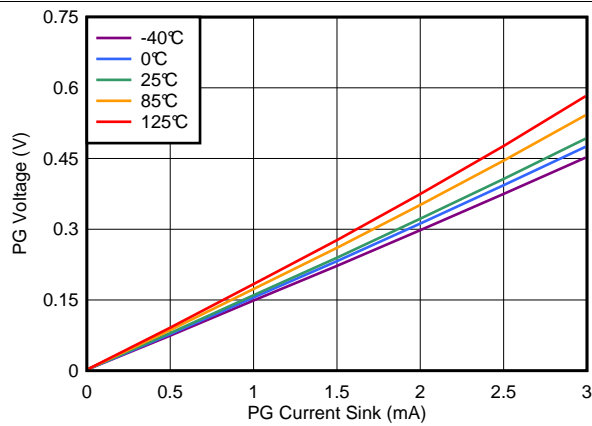

图 45. PG Threshold vs Temperature

7 Detailed Description

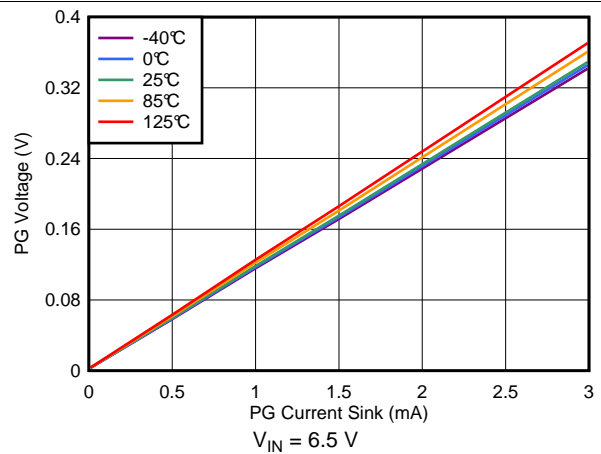
7.1 Overview

The TPS7A85 is a high-current (4 A), low-noise (4.4 μV_{RMS}), high accuracy (1%) low-dropout linear voltage regulator (LDO). These features make the device a robust solution to solve many challenging problems in generating a clean, accurate power supply.

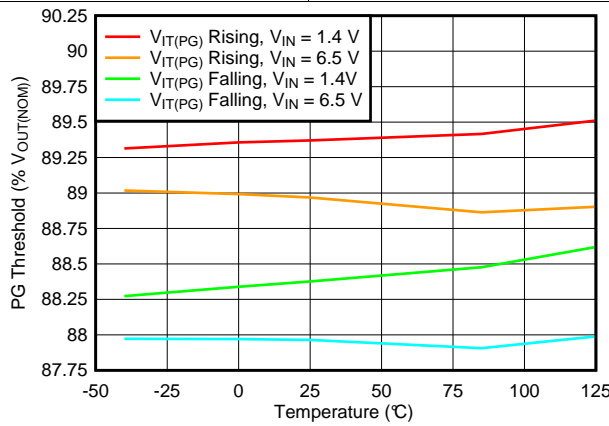
The TPS7A85 has several features that make the device useful in a variety of applications. As detailed in the [Functional Block Diagram](#) section, these features include:

- Low-noise, high-PSRR output
- ANY-OUT resistor network
- Optional bias rail
- Power-good (PG) output
- Programmable soft-start
- Foldback current limit
- Enable circuitry
- Active discharge
- Thermal protection

Overall, these features make the TPS7A85 the component of choice because of its versatility and ability to generate a supply for most applications.

7.2 Functional Block Diagram

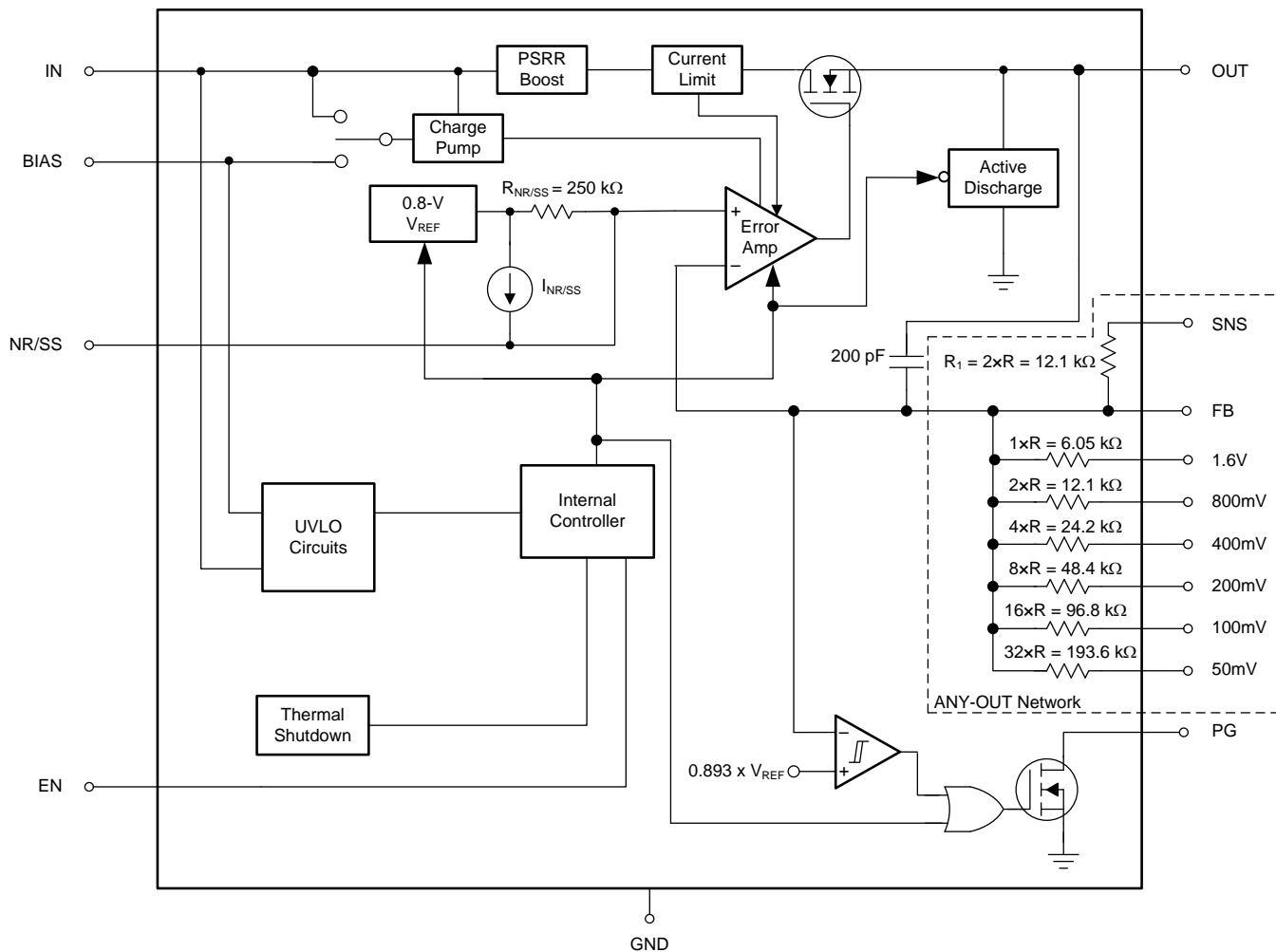

NOTE: For the ANY-OUT network, the ratios between the values are highly accurate as a result of matching, but the actual resistance can vary significantly from the values listed.

7.3 Feature Description

7.3.1 Low-Noise, High-PSRR Output

The TPS7A85 includes a low-noise reference and error amplifier ensuring minimal noise during operation. The NR/SS capacitor ($C_{NR/SS}$) and feed-forward capacitor (C_{FF}) are the most effective way to reduce device noise. $C_{NR/SS}$ filters the noise from the reference and C_{FF} filters the noise from the error amplifier. The noise contribution from the charge pump is minimal. The overall noise of the system at low output voltages can be reduced by using a bias rail because this rail provides more headroom for internal circuitry.

The high power-supply rejection ratio (PSRR) of the TPS7A85 ensures minimal coupling of input supply noise to the output. The PSRR performance primarily results from a high-bandwidth, high-gain error amplifier and an innovative circuit to boost the PSRR between 200 kHz and 1 MHz.

The combination of a low noise floor and high PSRR ensure that the device provides a clean supply to the application; see the [Optimizing Noise and PSRR](#) section for more information on optimizing the noise and PSRR performance.

7.3.2 Integrated Resistance Network (ANY-OUT)

An internal feedback resistance network is provided, allowing the TPS7A85 output voltage to be programmed easily between 0.8 V to 3.95 V with a 50-mV step by tying the ANY-OUT pins to ground. Tying the ANY-OUT pins to SNS increases the resolution but limits the range of the output voltage because the effective value of R_1 is decreased. The ANY-OUT network provides excellent accuracy across output voltage and temperature; see the [Application and Implementation](#) section for more details.

7.3.3 Bias Rail

The device features a bias rail to enable low-input voltage, low-output (LILO) voltage operation by providing power to the internal circuitry of the device. The bias rail is required for operation with $V_{IN} < 1.4$ V.

An internal power MUX supplies the greater of either the input voltage or the bias voltage to an internal charge pump to power the internal circuitry. Unlike other LDOs that have a bias supply, the TPS7A85 does not have a minimum bias voltage with respect to the input supply because an internal charge pump is used instead.

The internal charge pump multiplies the output voltage of the power MUX by a factor of 4 to a maximum of typically 8 V; therefore, using a bias supply with $V_{IN} \leq 2.2$ V is recommended for optimal dc and ac performance. Sequencing requirements exist for when the bias rail is used; see the [Sequencing Requirements](#) section for more details.

7.3.4 Power-Good (PG) Function

The power-good circuit monitors the voltage at the feedback pin to indicate the status of the output voltage. When the feedback pin voltage falls below the PG threshold voltage ($V_{IT(PG)} + V_{HYS(PG)}$, typically 89.3%), the PG pin open-drain output engages and pulls the PG pin close to GND. When the feedback voltage exceeds the $V_{IT(PG)}$ threshold by an amount greater than $V_{HYS(PG)}$ (typically 91.3%), the PG pin becomes high impedance. By connecting a pullup resistor to an external supply, any downstream device can receive power-good as a logic signal that can be used for sequencing. Make sure that the external pullup supply voltage results in a valid logic signal for the receiving device or devices. Using a pullup resistor from 10 k Ω to 100 k Ω is recommended. Using an external voltage detector device such as the [TPS3702](#) is also recommended in applications where more accurate voltage monitoring or overvoltage monitoring is required.

The use of a feed-forward capacitor (C_{FF}) can cause glitches on start-up, and the power-good circuit may not function normally below the minimum input supply range. For more details on the use of the power-good circuitry, see the [Power-Good \(PG\) Operation](#) section.

7.3.5 Programmable Soft-Start

Soft-start refers to the ramp-up time of the output voltage during LDO turn-on after EN and UVLO exceed the respective threshold voltages. The noise-reduction capacitor ($C_{NR/SS}$) serves a dual purpose of both governing output noise reduction and programming the soft-start ramp time during turn-on. The start-up ramp is monotonic.

The majority of the ramp is linear; however, there is an offset voltage in the error amplifier that can cause a small initial jump in output voltage; see the [Application and Implementation](#) section on implementing a soft-start.

Feature Description (接下页)

7.3.6 Internal Current Limit (I_{LIM})

The internal current limit circuit is used to protect the LDO against high-load current faults or shorting events. During a current-limit event, the LDO sources constant current; therefore, the output voltage falls with decreased load impedance. Thermal shutdown can activate during a current limit event because of the high power dissipation typically found in these conditions. To ensure proper operation of the current limit, minimize the inductances to the input and load. Continuous operation in current limit is not recommended.

The foldback current limit crosses 0 A when $V_{OUT} < 0$ V and prevents the device from turning on into a negatively-biased output. See the [Negatively-Biased Output](#) section for additional ways to ensure start-up when the TPS7A85 output is pulled below ground.

If $V_{OUT} > V_{IN} + 0.3$ V, then reverse current can flow from the output to the input. The reverse current can cause damage to the device; therefore, limit this reverse current to 10% of the rated output current of the device. See the [Reverse Current Protection](#) section for more details.

7.3.7 Enable

The enable pin for the TPS7A85 is active high. The output of the TPS7A85 is turned on when the enable pin voltage is greater than its rising voltage threshold (1.1 V, max), and the output of the TPS7A85 is turned off when the enable pin voltage is less than its falling voltage threshold (0.5 V, min). A voltage less than 0.5 V on the enable pin disables all internal circuits. At the next turn-on this voltage ensures a normal start-up waveform with in-rush control, provided there is enough time to discharge the output capacitance.

When the enable functionality is not desired, EN must be tied to V_{IN} . However, when the enable functionality is desired, the enable voltage must come after V_{IN} is above $V_{UVLO1(IN)}$ when a BIAS rail is used; see the [Application and Implementation](#) section for further details.

7.3.8 Active Discharge Circuit

The TPS7A85 has an internal pulldown MOSFET that connects a resistance of several hundred ohms to ground when the device is disabled to actively discharge the output voltage when the device is disabled.

Do not rely on the active discharge circuit for discharging a large amount of output capacitance after the input supply has collapsed because reverse current can possibly flow from the output to the input. This reverse current flow can cause damage to the device. Limit reverse current to no more than 10% of the device rated current for a short period of time; see the [Reverse Current Protection](#) section for more details.

7.3.9 Undervoltage Lockout (UVLO)

The undervoltage lockout (UVLO) circuit monitors the input and bias voltage (V_{IN} and V_{BIAS} , respectively) to prevent the device from turning on before V_{IN} and V_{BIAS} rise above the lockout voltage. The UVLO circuit also disables the output of the device when V_{IN} or V_{BIAS} fall below the lockout voltage.

The UVLO circuit responds quickly to glitches on V_{IN} or V_{BIAS} and attempts to disable the output of the device if either of these rails collapse. As a result of the fast response time of the input supply UVLO circuit, fast slew rate and short duration line transients well below the input supply UVLO falling threshold can cause momentary glitches during the edges of the transient; see the [Application and Implementation](#) section for more details.

7.3.10 Thermal Protection

The TPS7A85 contains a thermal shutdown protection circuit to disable the device when thermal junction temperature (T_J) of the main pass-FET exceeds 160°C (typical). Thermal shutdown hysteresis assures that the LDO resets again (turns on) when the temperature falls to 140°C (typical). The thermal time-constant of the semiconductor die is fairly short, and thus the device may cycle on and off when thermal shutdown is reached until the power dissipation is reduced.

For reliable operation, limit the junction temperature to a maximum of 125°C. Operation above 125°C causes the device to exceed its operational specifications. Although the internal protection circuitry of the TPS7A85 is designed to protect against thermal overload conditions, this circuitry is not intended to replace proper heat sinking. Continuously running the TPS7A85 into thermal shutdown or above a junction temperature of 125°C reduces long-term reliability.

7.4 Device Functional Modes

7.4.1 Operation with $1.1\text{ V} \leq V_{\text{IN}} < 1.4\text{ V}$

The TPS7A85 requires a bias voltage on the BIAS pin greater than or equal to 3.0 V if the high-current input supply voltage is between 1.1 V to 1.4 V. The bias voltage pin consumes 2.3 mA, typically.

7.4.2 Operation with $1.4\text{ V} \leq V_{\text{IN}} \leq 6.5\text{ V}$

If the input voltage is equal to or exceeds 1.4 V, no BIAS voltage is required. The TPS7A85 is powered from either the input supply or the BIAS supply, whichever is greater. For higher performance, a BIAS rail is recommended for $V_{\text{IN}} \leq 2.2\text{ V}$.

7.4.3 Shutdown

Shutting down the device reduces the ground current of the device to a maximum of 25 μA .

8 Application and Implementation

注

Information in the following applications sections is not part of the TI component specification, and TI does not warrant its accuracy or completeness. TI's customers are responsible for determining suitability of components for their purposes. Customers should validate and test their design implementation to confirm system functionality.

8.1 Application Information

The TPS7A85 is a linear voltage regulator with an input voltage range of 1.1 V to 6.5 V and an output voltage range of 0.8 V to 5.0 V with a 1% accuracy and a 4-A maximum output current. The TPS7A85 has an integrated charge pump for ease of use and an external bias rail to allow for the lowest dropout across the entire output voltage range.

8.1.1 Recommended Capacitor Types

The TPS7A85 is designed to be stable using low equivalent series resistance (ESR) ceramic capacitors at the input, output, and noise-reduction pin (NR, pin 13). Multilayer ceramic capacitors have become the industry standard for these types of applications and are recommended, but must be used with good judgment. Ceramic capacitors that employ X7R-, X5R-, and COG-rated dielectric materials provide relatively good capacitive stability across temperature, whereas the use of Y5V-rated capacitors is discouraged because of large variations in capacitance.

Regardless of the ceramic capacitor type selected, ceramic capacitance varies with operating voltage and temperature. As a rule of thumb, derate ceramic capacitors by at least 50%. The input and output capacitors recommended herein account for a effective capacitance derating of approximately 50%, but at high V_{IN} and V_{OUT} conditions (that is, $V_{IN} = 5.5$ V to $V_{OUT} = 5.0$ V) the derating can be greater than 50% and must be taken into consideration.

8.1.2 Input and Output Capacitor Requirements (C_{IN} and C_{OUT})

The TPS7A85 is designed and characterized for operation with ceramic capacitors of 47 μ F or greater (22 μ F or greater of effective capacitance) at the output and 10 μ F or greater (5 μ F or greater of effective capacitance) at the input. Using at least a 47- μ F capacitor is highly recommended at the input to minimize input impedance. Place the input and output capacitors as near as practical to the respective input and output pins to minimize trace parasitics. If the trace inductance from the input supply to the TPS7A85 is high, a fast current transient can cause V_{IN} to ring above the absolute maximum voltage rating and damage the device. This situation can be mitigated by additional input capacitors to dampen the ringing and to keep the ringing below the device absolute maximum ratings.

A combination of multiple output capacitors boosts the high-frequency PSRR, as illustrated in several of the PSRR curves. The combination of one 0805-sized, 47- μ F ceramic capacitor in parallel with two 0805-sized, 10- μ F ceramic capacitors with a sufficient voltage rating in conjunction with the PSRR boost circuit optimizes PSRR for the frequency range of 400 kHz to 700 kHz (which is a typical range for dc-dc supply switching frequency). This 47- μ F || 10- μ F || 10- μ F combination also ensures that at high input voltage and high output voltage configurations, the minimum effective capacitance is met. Many 0805-sized, 47- μ F ceramic capacitors have a voltage derating of approximately 60% to 75% at 5.0 V, so the addition of the two 10- μ F capacitors ensures that the capacitance is at or above 22 μ F.

8.1.3 Noise-Reduction and Soft-Start Capacitor ($C_{NR/SS}$)

The TPS7A85 features a programmable, monotonic, voltage-controlled soft-start that is set with an external capacitor ($C_{NR/SS}$). The use of an external $C_{NR/SS}$ is highly recommended, especially to minimize in-rush current into the output capacitors. This soft-start eliminates power-up initialization problems when powering field-programmable gate arrays (FPGAs), digital signal processors (DSPs), or other processors. The controlled voltage ramp of the output also reduces peak in-rush current during start-up, minimizing start-up transients to the input power bus.

Application Information (接下页)

To achieve a monotonic start-up, the TPS7A85 error amplifier tracks the voltage ramp of the external soft-start capacitor until the voltage approaches the internal reference. The soft-start ramp time depends on the soft-start charging current ($I_{NR/SS}$), the soft-start capacitance ($C_{NR/SS}$), and the internal reference ($V_{NR/SS}$). Soft-start ramp time can be calculated with [公式 1](#):

$$t_{SS} = (V_{NR/SS} \times C_{NR/SS}) / I_{NR/SS} \quad (1)$$

Note that $I_{NR/SS}$ is provided in the [Electrical Characteristics](#) table and has a typical value of 6.2 μ A.

The noise-reduction capacitor, in conjunction with the noise-reduction resistor, forms a low-pass filter (LPF) that filters out the noise from the reference before being gained up with the error amplifier, thereby reducing the device noise floor. The LPF is a single-pole filter and the cutoff frequency can be calculated with [公式 2](#). The typical value of R_{NR} is 250 k Ω . Increasing the $C_{NR/SS}$ capacitor has a greater affect because the output voltage increases when the noise from the reference is gained up even more at higher output voltages. For low-noise applications, a 10-nF to 1- μ F $C_{NR/SS}$ is recommended.

$$f_{cutoff} = 1 / (2 \times \pi \times R_{NR} \times C_{NR/SS}) \quad (2)$$

8.1.4 Feed-Forward Capacitor (C_{FF})

Although a feed-forward capacitor (C_{FF}) from the FB pin to the OUT pin is not required to achieve stability, a 10-nF external feed-forward capacitor optimizes the transient, noise, and PSRR performance. A higher capacitance C_{FF} can be used; however, the start-up time is longer and the power-good signal can incorrectly indicate that the output voltage is settled. To ensure proper PG functionality the time constant defined by $C_{NR/SS}$ must be greater than or equal to the time constant from the C_{FF} . For a detailed description, see application report *Pros and Cons of Using a Feed-Forward Capacitor with a Low Dropout Regulator*, [SBVA042](#).

8.1.5 Soft-Start and In-Rush Current

Soft-start refers to the ramp-up characteristic of the output voltage during LDO turn-on after EN and both UVLOs exceed their threshold voltages. The noise-reduction capacitor serves a dual purpose of both governing output noise reduction and programming the soft-start ramp during turn-on.

The soft-start ramp is not fully linear as the error amplifier has a several millivolt offset voltage. The output voltage starts to ramp only after the voltage created by the soft-start circuit increases above this offset voltage, at which point the output rises quickly to the voltage on the NR/SS pin. After this initial jump, the voltage rises at the ramp rate determined by the soft-start function. This jump typically does not cause a problem in applications because the quick rise in the output voltage has a very small amplitude.

In-rush current is defined as the current into the LDO at the IN pin during start-up. In-rush current then consists primarily of the sum of load current and the current used to charge the output capacitor. This current is difficult to measure because the input capacitor must be removed, which is not recommended. However, this soft-start current can be estimated by [公式 3](#):

$$I_{OUT(t)} = \left[\frac{C_{OUT} \times dV_{OUT}(t)}{dt} \right] + \left[\frac{V_{OUT}(t)}{R_{LOAD}} \right]$$

where:

- $V_{OUT}(t)$ is the instantaneous output voltage of the turn-on ramp
 - $dV_{OUT}(t) / dt$ is the slope of the V_{OUT} ramp
 - R_{LOAD} is the resistive load impedance
- (3)

8.1.6 Optimizing Noise and PSRR

The ultra-low noise floor and PSRR of the device can be improved by careful selection of:

- $C_{NR/SS}$ for the low-frequency range
- C_{FF} for the mid-band frequency range
- C_{OUT} for the high-frequency range
- $V_{IN} - V_{OUT}$ for all frequencies, and
- V_{BIAS} at lower input voltages

Application Information (接下页)

The noise-reduction capacitor filters out low-frequency noise from the reference and the feed-forward capacitor reduces output voltage noise by filtering out the mid-band frequency noise. However, a large feed-forward capacitor can create some new issues that are discussed in application report *Pros and Cons of Using a Feed-Forward Capacitor with a Low Dropout Regulator*, [SBVA042](#).

Note that a large output capacitor reduces high-frequency output voltage noise. Additionally, a bias rail or higher input voltage improves the noise because greater headroom is provided for the internal circuits. A high power dissipation across the die increases the output noise because of the increase in junction temperature.

A larger noise-reduction capacitor improves low-frequency PSRR by filtering any noise coupling from the input into the reference. The feed-forward capacitor can be optimized by placing a pole-zero pair near the edge of the loop bandwidth and pushing out the loop bandwidth, thus improving mid-band PSRR. Larger output capacitors and various output capacitors can be used to improve high-frequency PSRR; see [图 7](#) for more details.

A higher input voltage improves PSRR by providing the device more headroom to respond to noise on the input; see [图 2](#). A bias rail also improves the PSRR at lower input voltages because greater headroom is provided for the internal circuits. [表 1](#) lists the output voltage noise for the 10-Hz to 100-kHz band at a 5.0-V output for a variety of conditions with an input voltage of 5.6 V, an R_1 of 12.1 k Ω , and a load current of 4 A. The 5.0-V output is chosen because this output is the worst-case condition for output voltage noise. Note that the input voltage is 5.6 V, not 5.5 V as provided in the [Electrical Characteristics](#) table. The higher input voltage limits the maximum ambient temperature to below 40°C on a standard-JEDEC high-K board; see the [Power Dissipation \(\$P_D\$ \)](#) section for more information.

表 1. Output Noise Voltage at a 5.0-V Output with a 5.6-V Input

$C_{NR/SS}$ (nF)	C_{FF} (nF)	C_{OUT} (μ F)	OUTPUT VOLTAGE NOISE (μ V _{RMS})
10	10	47 10 10	12.3
100	10	47 10 10	8.4
100	100	47 10 10	6.6
100	100	1000	6.4

8.1.6.1 Charge Pump Noise

The device internal charge pump generates a minimal amount of noise, as shown in 图 46.

Using a bias rail minimizes the internal charge pump noise when the internal voltage is clamped, thereby reducing the overall output noise floor.

The high-frequency components of the output voltage noise density curve are filtered out in most applications by using 10-nF to 100-nF bypass capacitors close to the load. Using a ferrite bead between the LDO output and the load input capacitors forms a pi-filter, further reducing the high-frequency noise contribution.



图 46. Charge Pump Noise

8.1.7 ANY-OUT Programmable Output Voltage

The TPS7A85 can either use external resistors or the internally-matched ANY-OUT feedback resistor network to set the output voltage. The ANY-OUT resistors are accessible via pins 2 and 5 to 11 and are used to program the regulated output voltage. Each pin can be connected to ground (active) or left open (floating), or connected to SNS. ANY-OUT programming is set by 公式 4 as the sum of the internal reference voltage ($V_{NR/SS} = 0.8\text{ V}$) plus the accumulated sum of the respective voltages assigned to each active pin; that is, 50mV (pin 5), 100mV (pin 6), 200mV (pin 7), 400mV (pin 9), 800mV (pin 10), or 1.6V (pin 11). 表 2 summarizes these voltage values associated with each active pin setting for reference. By leaving all program pins open or floating, the output is thereby programmed to the minimum possible output voltage equal to V_{FB} .

$$V_{OUT} = V_{NR/SS} + (\Sigma \text{ ANY-OUT Pins to Ground}) \tag{4}$$

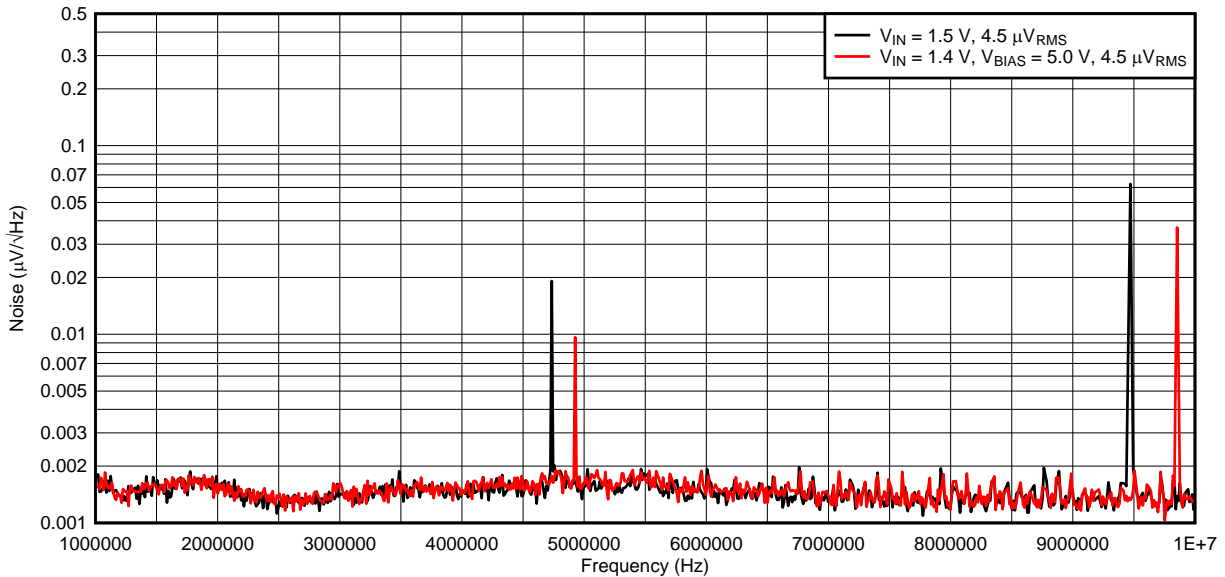
表 2. ANY-OUT Programmable Output Voltage

ANY-OUT PROGRAM PINS (Active Low)	ADDITIVE OUTPUT VOLTAGE LEVEL
Pin 5 (50mV)	50 mV
Pin 6 (100mV)	100 mV
Pin 7 (200mV)	200 mV
Pin 9 (400mV)	400 mV
Pin 10 (800mV)	800 mV
Pin 11 (1.6V)	1.6 V

表 3 provides a full list of target output voltages and corresponding pin settings when the ANY-OUT pins are only tied to ground or left floating. The voltage setting pins have a binary weight; therefore, the output voltage can be programmed to any value from 0.8 V to 3.95 V in 50-mV steps when tying these pins to ground. There are several alternative ways to set the output voltage. The program pins can be driven by using external general-purpose input/output pins (GPIOs), manually connected using 0-Ω resistors (or left open), or hardwired by the given layout of the printed circuit board (PCB) to set the ANY-OUT voltage. As with the adjustable operation, the output voltage is set according to 公式 5 except that R_1 and R_2 are internally integrated and matched for higher accuracy. Tying any of the ANY-OUT pins to SNS can increase the resolution of the internal feedback network by lowering the value of R_1 ; see the [Increasing ANY-OUT Resolution for LILO Conditions](#) section for additional information.

$$V_{OUT} = V_{NR/SS} \times (1 + R_1 / R_2) \quad (5)$$

注

For output voltages greater than 3.95 V, use a traditional adjustable configuration (see the [Adjustable Operation](#) section).

表 3. User-Configurable Output Voltage Settings

$V_{OUT(NOM)}$ (V)	50mV	100mV	200mV	400mV	800mV	1.6V	$V_{OUT(NOM)}$ (V)	50mV	100mV	200mV	400mV	800mV	1.6V
0.80	Open	Open	Open	Open	Open	Open	2.40	Open	Open	Open	Open	Open	GND
0.85	GND	Open	Open	Open	Open	Open	2.45	GND	Open	Open	Open	Open	GND
0.90	Open	GND	Open	Open	Open	Open	2.50	Open	GND	Open	Open	Open	GND
0.95	GND	GND	Open	Open	Open	Open	2.55	GND	GND	Open	Open	Open	GND
1.00	Open	Open	GND	Open	Open	Open	2.60	Open	Open	GND	Open	Open	GND
1.05	GND	Open	GND	Open	Open	Open	2.65	GND	Open	GND	Open	Open	GND
1.10	Open	GND	GND	Open	Open	Open	2.70	Open	GND	GND	Open	Open	GND
1.15	GND	GND	GND	Open	Open	Open	2.75	GND	GND	GND	Open	Open	GND
1.20	Open	Open	Open	GND	Open	Open	2.80	Open	Open	Open	GND	Open	GND
1.25	GND	Open	Open	GND	Open	Open	2.85	GND	Open	Open	GND	Open	GND
1.30	Open	GND	Open	GND	Open	Open	2.90	Open	GND	Open	GND	Open	GND
1.35	GND	GND	Open	GND	Open	Open	2.95	GND	GND	Open	GND	Open	GND
1.40	Open	Open	GND	GND	Open	Open	3.00	Open	Open	GND	GND	Open	GND
1.45	GND	Open	GND	GND	Open	Open	3.05	GND	Open	GND	GND	Open	GND
1.50	Open	GND	GND	GND	Open	Open	3.10	Open	GND	GND	GND	Open	GND
1.55	GND	GND	GND	GND	Open	Open	3.15	GND	GND	GND	GND	Open	GND
1.60	Open	Open	Open	Open	GND	Open	3.20	Open	Open	Open	Open	GND	GND
1.65	GND	Open	Open	Open	GND	Open	3.25	GND	Open	Open	Open	GND	GND
1.70	Open	GND	Open	Open	GND	Open	3.30	Open	GND	Open	Open	GND	GND
1.75	GND	GND	Open	Open	GND	Open	3.35	GND	GND	Open	Open	GND	GND
1.80	Open	Open	GND	Open	GND	Open	3.40	Open	Open	GND	Open	GND	GND
1.85	GND	Open	GND	Open	GND	Open	3.45	GND	Open	GND	Open	GND	GND
1.90	Open	GND	GND	Open	GND	Open	3.50	Open	GND	GND	Open	GND	GND
1.95	GND	GND	GND	Open	GND	Open	3.55	GND	GND	GND	Open	GND	GND
2.00	Open	Open	Open	GND	GND	Open	3.60	Open	Open	Open	GND	GND	GND
2.05	GND	Open	Open	GND	GND	Open	3.65	GND	Open	Open	GND	GND	GND
2.10	Open	GND	Open	GND	GND	Open	3.70	Open	GND	Open	GND	GND	GND
2.15	GND	GND	Open	GND	GND	Open	3.75	GND	GND	Open	GND	GND	GND
2.20	Open	Open	GND	GND	GND	Open	3.80	Open	Open	GND	GND	GND	GND
2.25	GND	Open	GND	GND	GND	Open	3.85	GND	Open	GND	GND	GND	GND
2.30	Open	GND	GND	GND	GND	Open	3.90	Open	GND	GND	GND	GND	GND
2.35	GND	GND	GND	GND	GND	Open	3.95	GND	GND	GND	GND	GND	GND

8.1.8 ANY-OUT Operation

Considering the use of the ANY-OUT internal network (where the unit resistance of 1R is equal to 6.05 kΩ) the output voltage is set by grounding the appropriate control pins, as shown in 图 47. When grounded, all control pins add a specific voltage on top of the internal reference voltage ($V_{NR/SS} = 0.8\text{ V}$). The output voltage can be calculated by 公式 6 and 公式 7. 图 47 and 图 48 show a 3.3-V and a 0.9-V output voltage, respectively, that provides an example of the circuit usage with and without bias voltage.



图 47. ANY-OUT Configuration Circuit (3.3-V Output, No External Bias)

$$V_{OUT(nom)} = V_{NR/SS} + 1.6\text{ V} + 0.8\text{ V} + 0.1\text{ V} = 0.8\text{ V} + 1.6\text{ V} + 0.8\text{ V} + 0.1\text{ V} = 3.3\text{ V} \quad (6)$$

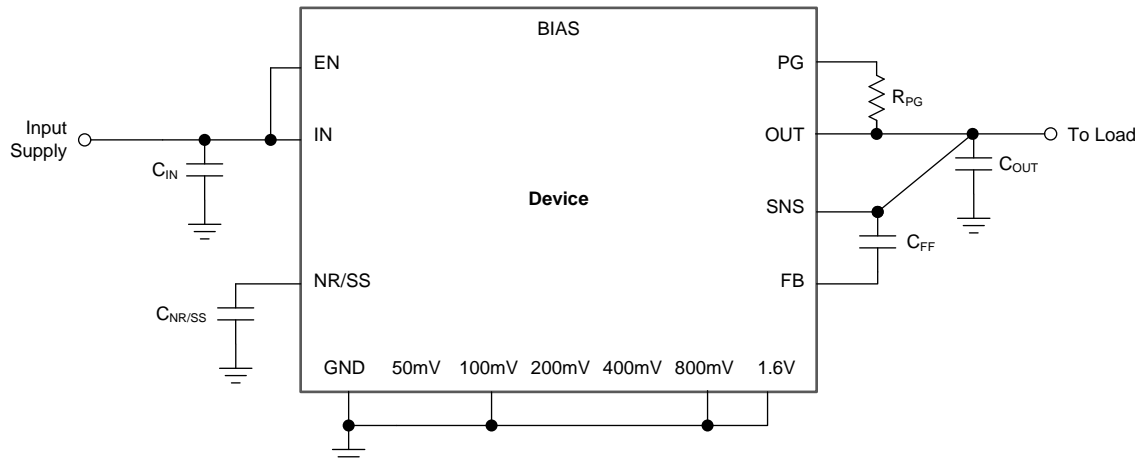

图 48. ANY-OUT Configuration Circuit (0.9-V Output with Bias)

$$V_{OUT(nom)} = V_{NR/SS} + 0.1\text{ V} = 0.8\text{ V} + 0.1\text{ V} = 0.9\text{ V} \quad (7)$$

8.1.9 Increasing ANY-OUT Resolution for LILO Conditions

As with the adjustable operation, the output voltage is set according to 公式 5, except that R_1 and R_2 are internally integrated and matched for higher accuracy. Tying any of the ANY-OUT pins to SNS can increase the resolution of the internal feedback network by lowering the value of R_1 . One of the more useful pin combinations is to tie the 800mV pin to SNS, which reduces the resolution by 50% to 25 mV but limits the range. The new ANY-OUT ranges are 0.8 V to 1.175 V and 1.6 V to 1.975 V. The new additive output voltage levels are listed in 表 4.

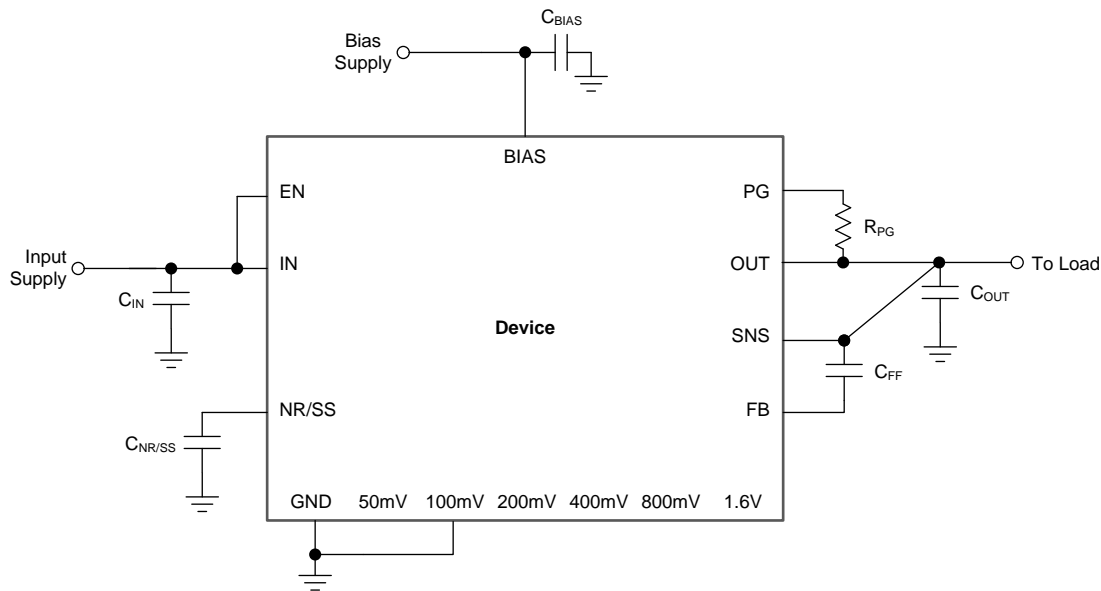
表 4. ANY-OUT Programmable Output Voltage with 800mV Tied to SNS

ANY-OUT PROGRAM PINS (Active Low)	ADDITIVE OUTPUT VOLTAGE LEVEL
Pin 5 (50mV)	25 mV
Pin 6 (100mV)	50 mV
Pin 7 (200mV)	100 mV
Pin 9 (400mV)	200 mV
Pin 11 (1.6V)	800 mV

8.1.10 Current Sharing

Current sharing is possible through the use of external operational amplifiers. For more details, see the reference design *6A Current-Sharing Dual LDO*, TIDU421.

8.1.11 Adjustable Operation

The TPS7A85 can either be used with the internal ANY-OUT network or by using external resistors. Using the ANY-OUT network allows the TPS7A85 to be programmed from 0.8 V to 3.95 V. To extend this output voltage range to 5.0 V, external resistors must be used. This configuration is referred to as the adjustable configuration of the TPS7A85 throughout this document. Regardless whether the internal resistor network or external resistors are used, the output voltage is set by two resistors, as shown in 图 49. Using the internal resistor ensures a 1% accurate output voltage and minimizes the number of external components.



图 49. Adjustable Operation

R_1 and R_2 can be calculated for any output voltage range using 公式 8. This resistive network must provide a current equal to or greater than 5 μ A for dc accuracy. Using an R_1 of 12.1 k Ω is recommended to optimize the noise and PSRR.

$$V_{OUT} = V_{NR/SS} \times (1 + R_1 / R_2) \quad (8)$$

表 5 shows the resistor combinations required to achieve several common rails using standard 1%-tolerance resistors.

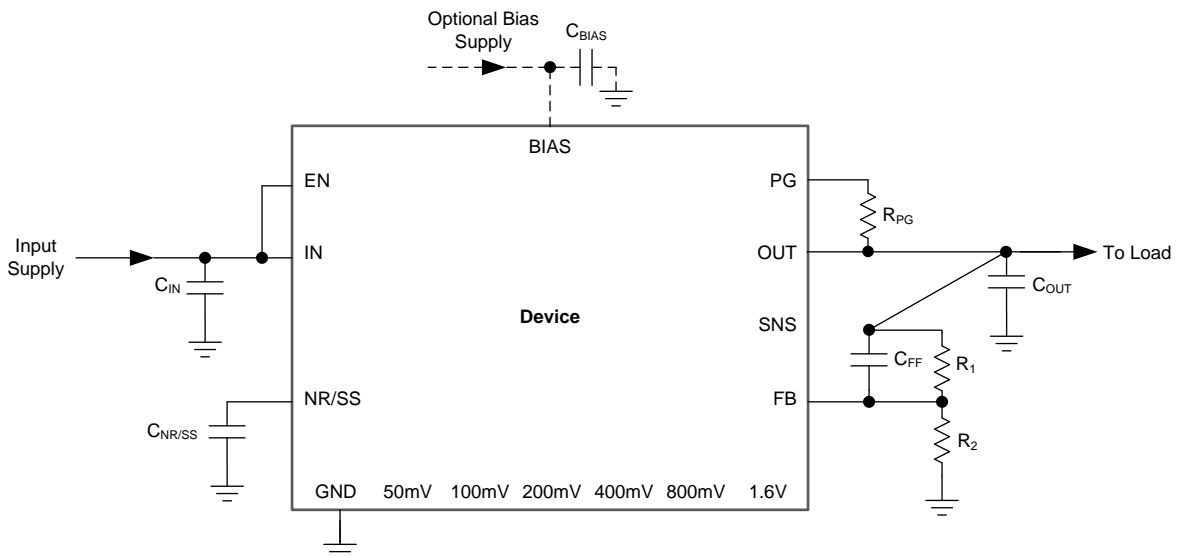
表 5. Recommended Feedback-Resistor Values⁽¹⁾

TARGETED OUTPUT VOLTAGE (V)	FEEDBACK RESISTOR VALUES		CALCULATED OUTPUT VOLTAGE (V)
	R ₁ (kΩ)	R ₂ (kΩ)	
0.9	12.4	100	0.899
0.95	12.4	66.5	0.949
1.00	12.4	49.9	0.999
1.10	12.4	33.2	1.099
1.20	12.4	24.9	1.198
1.50	12.4	14.3	1.494
1.80	12.4	10	1.798
1.90	12.1	8.87	1.89
2.50	12.4	5.9	2.48
2.85	12.1	4.75	2.838
3.00	12.1	4.42	2.990
3.30	11.8	3.74	3.324
3.60	12.1	3.48	3.582
4.5	11.8	2.55	4.502
5.00	12.4	2.37	4.985

(1) R₁ is connected from OUT to FB; R₂ is connected from FB to GND.

8.1.12 Sequencing Requirements

Supply and enable sequencing is only required when the bias rail is present. The start-up is always monotonic, independent of the sequencing requirements. Under these conditions the following requirements apply:

- V_{BIAS} and V_{IN} can be sequenced in any order, as long as V_{EN} is tied to V_{IN} or established after V_{IN}, as shown in 图 50.



图 50. Sequencing Diagram

Two typical application circuits for implementing the sequencing requirements are detailed in the [Sequencing with a Power-Good DC-DC Converter Pin](#) and [Sequencing with a Microcontroller \(MCU\)](#) sections.

8.1.12.1 Sequencing with a Power-Good DC-DC Converter Pin

When a dc-dc converter is used to power the device and the PG of the dc-dc converter is used to enable the device, pull PG up to V_{IN} , as shown in 图 51.

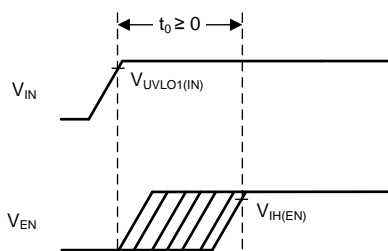

图 51. Sequencing with a DC-DC Converter and PG

8.1.12.2 Sequencing with a Microcontroller (MCU)

If a push-pull output stage is used to provide the enable signal to the device and the enable signal can possibly come before V_{IN} when a bias is present (such as with an MCU), convert the enable signal to an open-drain signal as shown in 图 52. Using an open-drain signal ensures that if the signal arrives before V_{IN} , then the enable voltage does not violate the sequencing requirement.

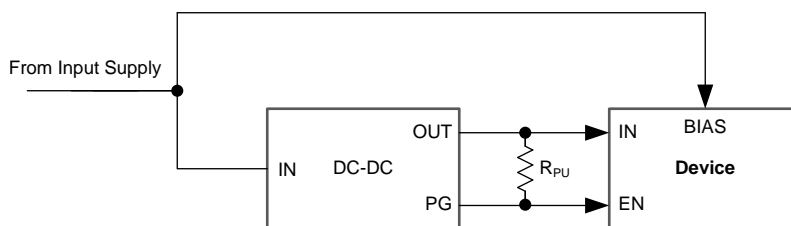

图 52. Push-Pull Enable to Open-Drain Enable

8.1.13 Power-Good (PG) Operation

To ensure proper operation of the power-good circuit, the pullup resistor value must be between 10 k Ω and 100 k Ω . The lower limit of 10 k Ω results from the maximum pulldown strength of the power-good transistor, and the upper limit of 100 k Ω results from the maximum leakage current at the power-good node. If the pullup resistor is outside of this range, then the power-good signal may not read a valid digital logic level.

Using a large C_{FF} with a small $C_{NR/SS}$ causes the power-good signal to incorrectly indicate that the output voltage has settled during turn-on. The C_{FF} time constant must be greater than the soft-start time constant to ensure proper operation of the PG during start-up. For a detailed description, see application report *Pros and Cons of Using a Feed-Forward Capacitor with a Low Dropout Regulator*, [SBVA042](#).

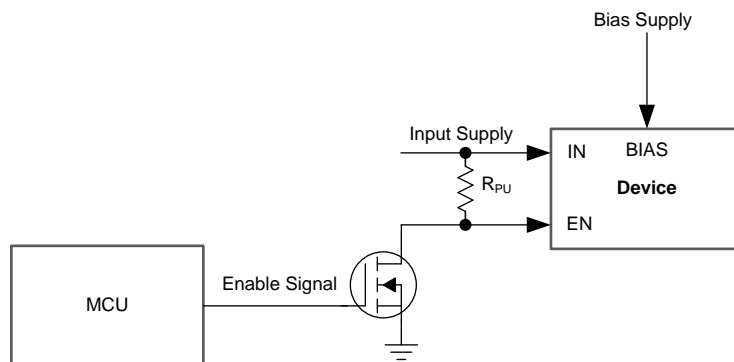
The state of PG is only valid when the device operates above the minimum supply voltage. During short UVLO events and at light loads, power-good does not assert because the output voltage is sustained by the output capacitance.

8.1.14 Undervoltage Lockout (UVLO) Operation

The UVLO circuit ensures that the device stays disabled before its input or bias supplies reach the minimum operational voltage range, and ensures that the device shuts down when the input supply or bias supply collapse.

The UVLO circuit has a minimum response time of several microseconds to fully assert. During this time, a downward line transient below approximately 0.8 V causes the UVLO to assert for a short time; however, the UVLO circuit does not have enough stored energy to fully discharge the internal circuits inside of the device. When the UVLO circuit does not fully discharge, the internal circuits of the output are not fully disabled.

The effect of the downward line transient can be mitigated by either using a larger input capacitor to limit the fall time of the input supply when operating near the minimum V_{IN} , or by using a bias rail.

图 53 shows the UVLO circuit response to various input voltage events. The diagram can be separated into the following parts:

- Region A: The device does not turn on until the input reaches the UVLO rising threshold.
- Region B: Normal operation with a regulated output
- Region C: Brownout event above the UVLO falling threshold (UVLO rising threshold – UVLO hysteresis). The output may fall out of regulation but the device is still enabled.
- Region D: Normal operation with a regulated output
- Region E: Brownout event below the UVLO falling threshold. The device is disabled in most cases and the output falls because of the load and active discharge circuit. The device is reenabled when the UVLO rising threshold is reached by the input voltage and a normal start-up then follows.
- Region F: Normal operation followed by the input falling to the UVLO falling threshold.
- Region G: The device is disabled when the input voltage falls below the UVLO falling threshold to 0 V. The output falls because of the load and active discharge circuit.



图 53. Typical UVLO Operation

8.1.15 Dropout Voltage (V_{DO})

Generally speaking, the dropout voltage often refers to the minimum voltage difference between the input and output voltage ($V_{DO} = V_{IN} - V_{OUT}$) that is required for regulation. When V_{IN} drops below the required V_{DO} for the given load current, the device functions as a resistive switch and does not regulate output voltage. Dropout voltage is proportional to the output current because the device is operating as a resistive switch; see 图 25, 图 26, and 图 27.

Dropout voltage is affected by the drive strength for the gate of the pass element, which is nonlinear with respect to V_{IN} on this device because of the internal charge pump. The charge pump causes a higher dropout voltage at lower input voltages when a bias rail is not used, as illustrated in 图 23.

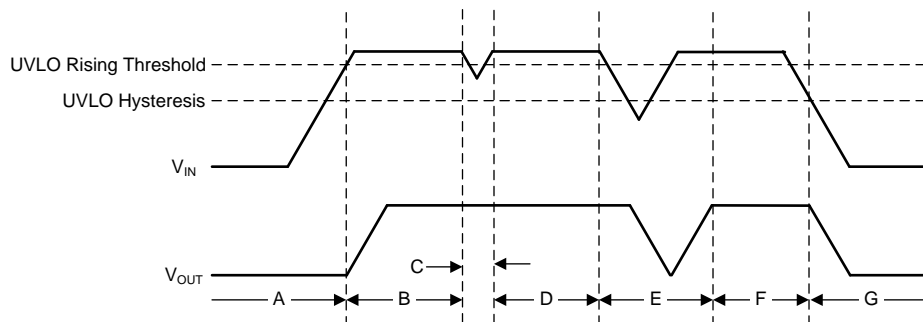
For this device, dropout voltage increases exponentially when the input voltage nears its maximum operating voltage because the charge pump is internally clamped to 8.0 V; see 图 23 and 图 24.

8.1.16 Behavior when Transitioning from Dropout into Regulation

Some applications may have transients that place the device into dropout, especially because this device is a high-current linear regulator. A typical application with these conditions requires setting $V_{IN} \leq V_{DO}$ in order to keep the device junction temperature within its specified operating range. A load transient or line transient in these conditions can place the device into dropout, such as a load transient from 1 A to 4 A at $1A/\mu s$ when operating with a V_{IN} of 5.4 V and a V_{OUT} of 5.0 V.

The load transient saturates the error amplifier output stage when the pass element is fully driven on, thus making the pass element function like a resistor from V_{IN} to V_{OUT} . The error amplifier response time to this load transient ($I_{OUT} = 4 A$ to $1 A$ at $1 A/\mu s$) is limited because the error amplifier must first recover from saturation and then place the pass element back into active mode. During the recovery from the load transient, V_{OUT} overshoots because the pass element is functioning as a resistor from V_{IN} to V_{OUT} . If operating under these conditions, apply a higher dc load or increase the output capacitance to reduce the overshoot because these solutions provide a path to dissipate the excess charge.

8.1.17 Load Transient Response

The load-step transient response is the output voltage response by the LDO to a step in load current, whereby output voltage regulation is maintained; see [图 18](#). There are two key transitions during a load transient response: the transition from a light to a heavy load and the transition from a heavy to a light load. The regions shown in [图 54](#) are broken down in this section. Regions A, E, and H are where the output voltage is in steady-state.

During transitions from a light load to a heavy load, the:

- Initial voltage dip is a result of the depletion of the output capacitor charge and parasitic impedance to the output capacitor (region B).
- Recovery from the dip results from the LDO increasing its sourcing current, and leads to output voltage regulation (region C).

During transitions from a heavy load to a light load, the:

- Initial voltage rise results from the LDO sourcing a large current, and leads to the output capacitor charge to increase (region F).
- Recovery from the rise results from the LDO decreasing its sourcing current in combination with the load discharging the output capacitor (region G).

Transitions between current levels changes the internal power dissipation because the TPS7A85 is a high-current device (region D). The change in power dissipation changes the die temperature during these transitions, and leads to a slightly different voltage level. This different output voltage level shows up in the various load transient responses; see [图 18](#).

A larger output capacitance reduces the peaks during a load transient but slows down the response time of the device. A larger dc load also reduces the peaks because the amplitude of the transition is lowered and a higher current discharge path is provided for the output capacitor; see [图 20](#).



图 54. Load Transient Waveform

8.1.18 Negatively-Biased Output

The device does not start or operate as expected if the output voltage is pulled below ground. This issue commonly occurs when powering a split-rail system where the negative rail is established before the device is enabled. Several application solutions are possible, such as:

- Enable the device before the negative regulator and disable the device after the negative regulator.
- Delaying the EN voltage with respect to the IN voltage allows the internal pulldown resistor to discharge any voltage at OUT. If the discharge circuit is not strong enough to keep the output voltage at ground, then use an external pulldown resistor.
- Place a zener diode from IN to OUT to provide a small positive dc bias on the output when the input is supplied to the device, as shown in [图 55](#).

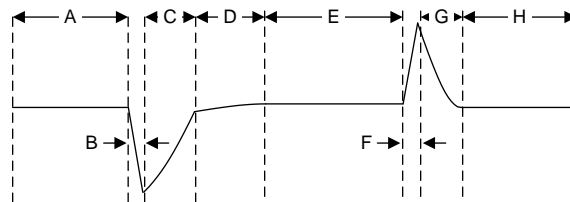

图 55. Zener Diode Placed from IN to OUT

- Use a PMOSFET to isolate the output of the device from the load causing the negative bias when the device is off, as shown in [图 56](#).

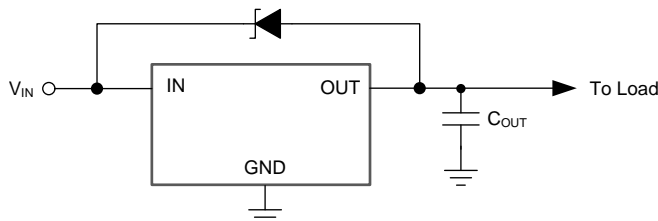

图 56. PMOSFET to Isolate the Output from the Load

8.1.19 Reverse Current Protection

As with most LDOs, this device can be damaged by excessive reverse current.

Conditions where excessive reverse current can occur are outlined in this section, all of which can exceed the absolute maximum rating of $V_{OUT} > V_{IN} + 0.3\text{ V}$:

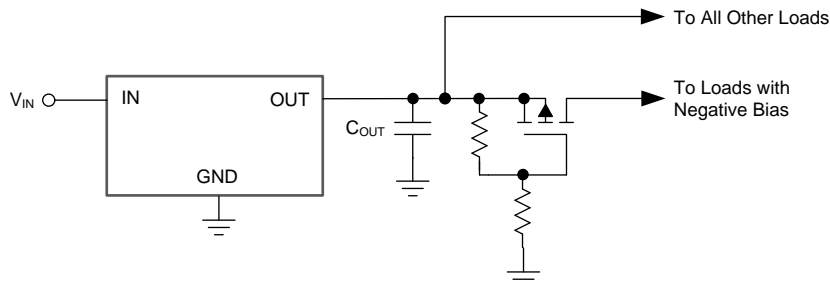
- If the device has a large C_{OUT} , then the input supply collapses quickly and the load current becomes very small
- The output is biased when the input supply is not established
- The output is biased above the input supply

If an excessive reverse current flow is expected in the application, then external protection must be used to protect the device. 图 57 shows one approach of protecting the device.



图 57. Example Circuit for Reverse Current Protection Using a Schottky Diode

8.1.20 Power Dissipation (P_D)

Circuit reliability demands that proper consideration be given to device power dissipation, location of the circuit on the printed circuit board (PCB), and correct sizing of the thermal plane. The PCB area around the regulator must be as free as possible of other heat-generating devices that cause added thermal stresses.

As a first-order approximation, power dissipation in the regulator depends on the input-to-output voltage difference and load conditions. P_D can be approximated using 公式 9:

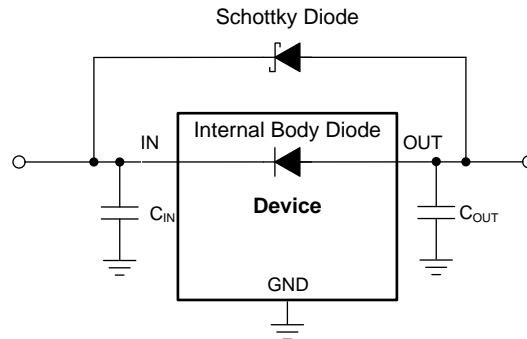
$$P_D = (V_{OUT} - V_{IN}) \times I_{OUT} \quad (9)$$

An important note is that power dissipation can be minimized, and thus greater efficiency achieved, by proper selection of the system voltage rails. Proper selection allows the minimum input-to-output voltage differential to be obtained. The low dropout of the TPS7A85 allows for maximum efficiency across a wide range of output voltages.

The main heat conduction path for the device is through the thermal pad on the package. As such, the thermal pad must be soldered to a copper pad area under the device. This pad area contains an array of plated vias that conduct heat to any inner plane areas or to a bottom-side copper plane.

The maximum power dissipation determines the maximum allowable junction temperature (T_J) for the device. Power dissipation and junction temperature are most often related by the junction-to-ambient thermal resistance (θ_{JA}) of the combined PCB and device package and the temperature of the ambient air (T_A), according to 公式 10. The equation is rearranged for output current in 公式 11.

$$T_J = T_A + (\theta_{JA} \times P_D) \quad (10)$$

$$I_{OUT} = (T_J - T_A) / [\theta_{JA} \times (V_{IN} - V_{OUT})] \quad (11)$$

Unfortunately, this thermal resistance (θ_{JA}) is highly dependent on the heat-spreading capability built into the particular PCB design, and therefore varies according to the total copper area, copper weight, and location of the planes. The θ_{JA} recorded in the *Electrical Characteristics* table is determined by the JEDEC standard, PCB, and copper-spreading area, and is only used as a relative measure of package thermal performance. Note that for a well-designed thermal layout, θ_{JA} is actually the sum of the VQFN package junction-to-case (bottom) thermal resistance (θ_{JCbott}) plus the thermal resistance contribution by the PCB copper.

8.1.20.1 Estimating Junction Temperature

The JEDEC standard now recommends the use of psi (Ψ) thermal metrics to estimate the junction temperatures of the LDO when in-circuit on a typical PCB board application. These metrics are not strictly speaking thermal resistances, but rather offer practical and relative means of estimating junction temperatures. These psi metrics are determined to be significantly independent of the copper-spreading area. The key thermal metrics (Ψ_{JT} and Ψ_{JB}) are given in the [Electrical Characteristics](#) table and are used in accordance with [公式 12](#).

$$\Psi_{JT}: T_J = T_T + \Psi_{JT} \times P_D$$

$$\Psi_{JB}: T_J = T_B + \Psi_{JB} \times P_D$$

where:

- P_D is the power dissipated as explained in [公式 9](#)
- T_T is the temperature at the center-top of the device package, and
- T_B is the PCB surface temperature measured 1 mm from the device package and centered on the package edge (12)

8.1.20.2 Recommended Area for Continuous Operation (RACO)

The operational area of an LDO is limited by the dropout voltage, output current, junction temperature, and input voltage. The recommended area for continuous operation for a linear regulator can be separated into the following parts, and is shown in [图 58](#):

- Limited by dropout: Dropout voltage limits the minimum differential voltage between the input and the output ($V_{IN} - V_{OUT}$) at a given output current level; see the [Dropout Voltage \(\$V_{DO}\$ \)](#) section for more details.
- Limited by rated output current: The rated output current limits the maximum recommended output current level. Exceeding this rating causes the device to fall out of specification.
- Limited by thermals: The shape of the slope is given by [公式 11](#). The slope is nonlinear because the junction temperature of the LDO is controlled by the power dissipation across the LDO; therefore, when $V_{IN} - V_{OUT}$ increases, the output current must decrease in order to ensure that the rated junction temperature of the device is not exceeded. Exceeding this rating can cause the device to fall out of specifications and reduces long-term reliability.
- Limited by V_{IN} range: The rated input voltage range governs both the minimum and maximum of $V_{IN} - V_{OUT}$.



图 58. Continuous Operation Slope Region Description

图 59 到 图 64 显示该器件在 JEDEC 标准高-K 板上以 $\theta_{JA} = 35.4^{\circ}\text{C}/\text{W}$ 为条件的推荐工作区域曲线，如 *Electrical Characteristics* 表中所给。

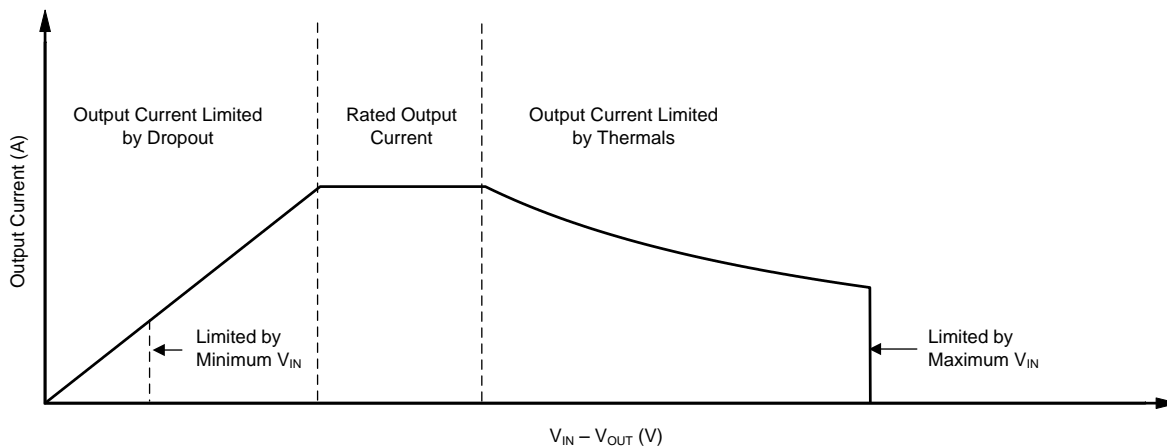
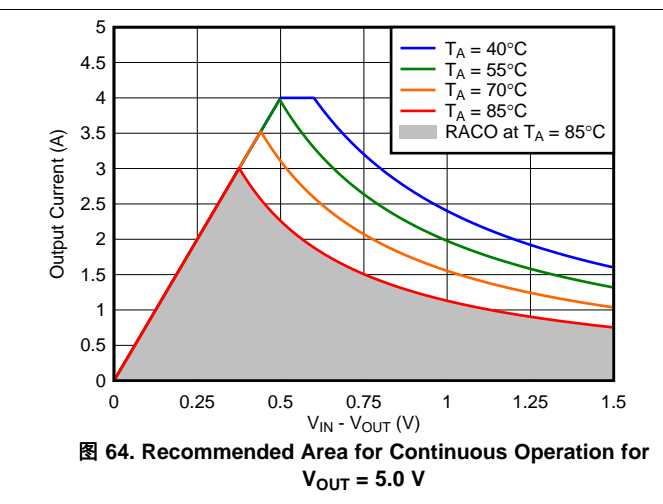
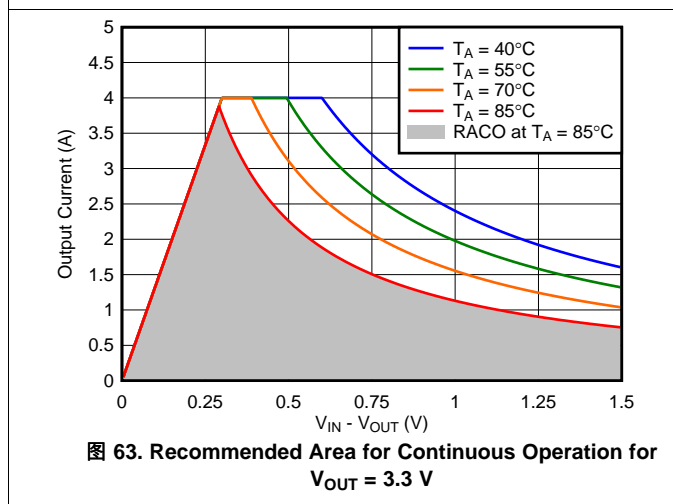
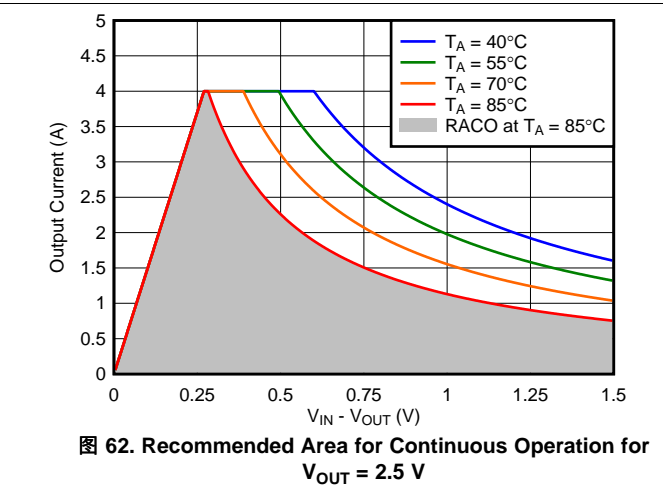
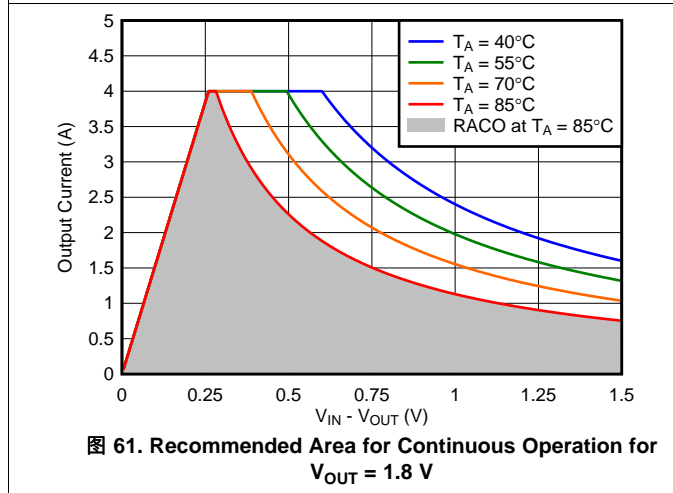
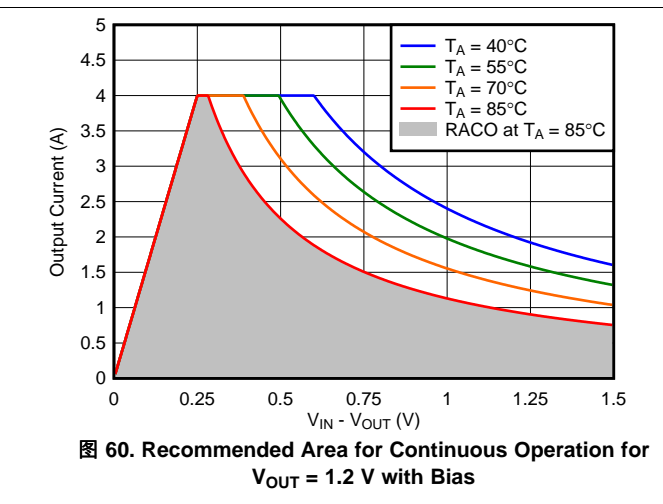
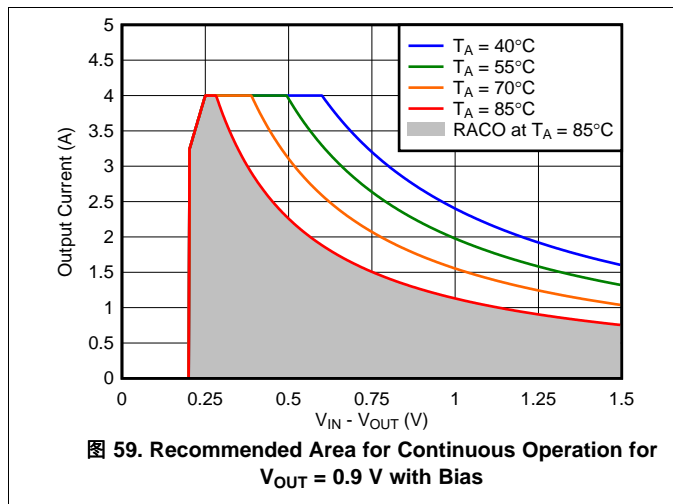

8.2 Typical Applications

8.2.1 Low-Input, Low-Output (LILo) Voltage Conditions

This section discusses the implementation of the TPS7A85 using the ANY-OUT configuration to regulate a 4.0-A load requiring good PSRR at high frequency with low noise at 0.9 V using a 1.3-V input voltage and a 5.0-V bias supply. The schematic for this typical application circuit is provided in [图 65](#).



图 65. Typical Application

8.2.1.1 Design Requirements

For this design example, use the parameters listed in [表 6](#) as the input parameters.

表 6. Design Parameters

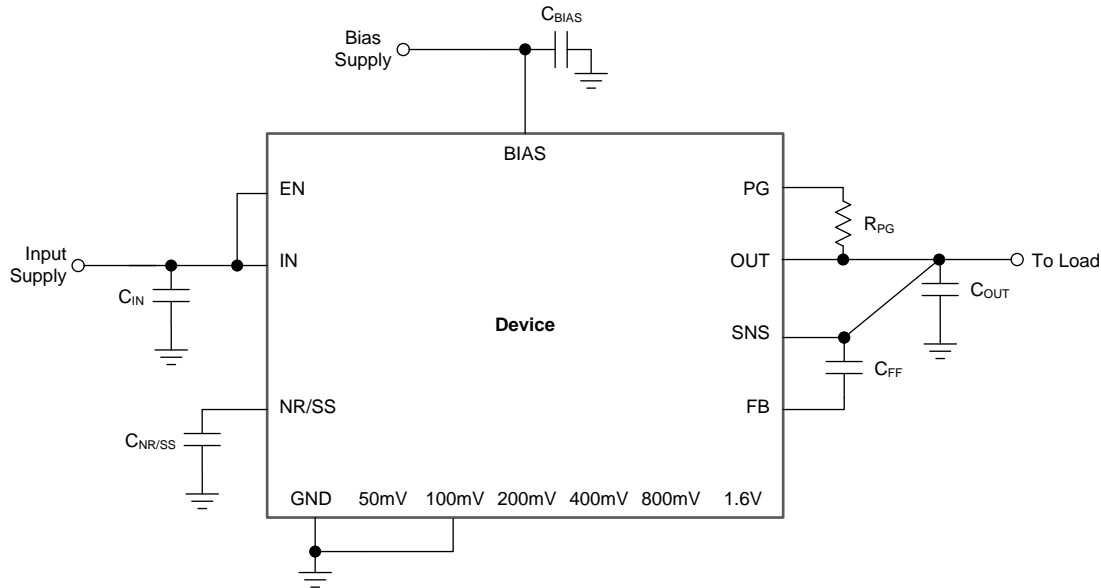
PARAMETER	DESIGN REQUIREMENT
Input voltage	1.4 V, $\pm 3\%$, provided by the dc-dc converter switching at 500 kHz
Output voltage	0.9 V, $\pm 1\%$
Output current	4.0 A (maximum), 100 mA (minimum)
RMS noise, 10 Hz to 100 kHz	$< 10 \mu\text{V}_{\text{RMS}}$
PSRR at 500 kHz	$> 40 \text{ dB}$
Start-up time	$< 25 \text{ ms}$

8.2.1.2 Detailed Design Procedure

For these conditions, the maximum dropout of the TPS7A85 is approximately 240 mV, thus a 400-mV headroom is sufficient for operation over both input and output voltage accuracy. The bias rail is provided for better performance for the LILo conditions. PSRR is greater than 40 dB in these conditions, as per [图 2](#). Noise is less than $10 \mu\text{V}_{\text{RMS}}$, as per [图 11](#).

The ANY-OUT internal resistor network is also used for maximum accuracy.

To achieve 0.9 V on the output, the 100mV pin is grounded. The voltage value of 100 mV is added to the 0.8-V internal reference voltage for $V_{\text{OUT(nom)}}$ equal to 0.9 V, as described in [公式 13](#).

$$V_{\text{OUT(nom)}} = V_{\text{NR/SS}} + 0.1 \text{ V} = 0.8 \text{ V} + 0.1 \text{ V} = 0.9 \text{ V} \quad (13)$$

Input and output capacitors are selected in accordance with the [Recommended Capacitor Types](#) section. Ceramic capacitances of 47 μF for the input and one 47- μF capacitor in parallel with two 10- μF capacitors for the output are selected.

To satisfy the required start-up time and still maintain low-noise performance, a 100-nF $C_{NR/SS}$ is selected. This value is calculated with 公式 14. To further minimize noise, a feed-forward capacitance (C_{FF}) of 10 nF is selected.

$$t_{SS} = (V_{NR/SS} \times C_{NR/SS}) / I_{NR/SS} \tag{14}$$

The maximum ambient temperature for this application is 40°C based on 图 59 and given the 3% accuracy of the input supply.

8.2.1.3 Application Curves

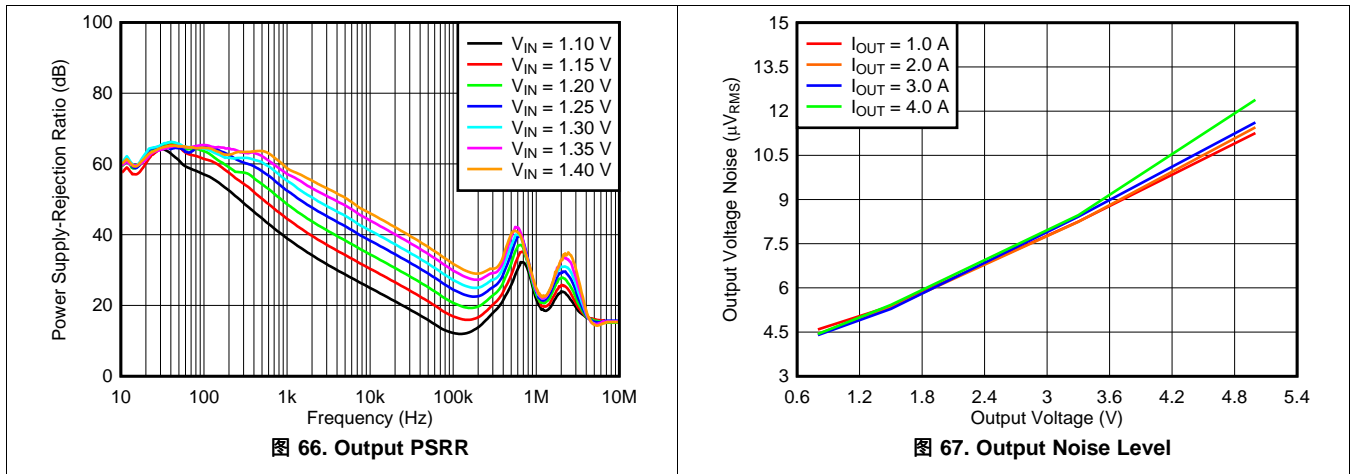

8.2.2 Typical Application for a 5.0-V Rail

This section discusses the implementation of the TPS7A85 using an adjustable feedback network to regulate a 4-A load requiring good PSRR at high frequency with low noise at an output voltage of 5.0 V. The schematic for this typical application circuit is provided in 图 68.



图 68. Typical Application

8.2.2.1 Design Requirements

For this design example, use the parameters listed in 表 6 as the input parameters.

表 7. Design Parameters

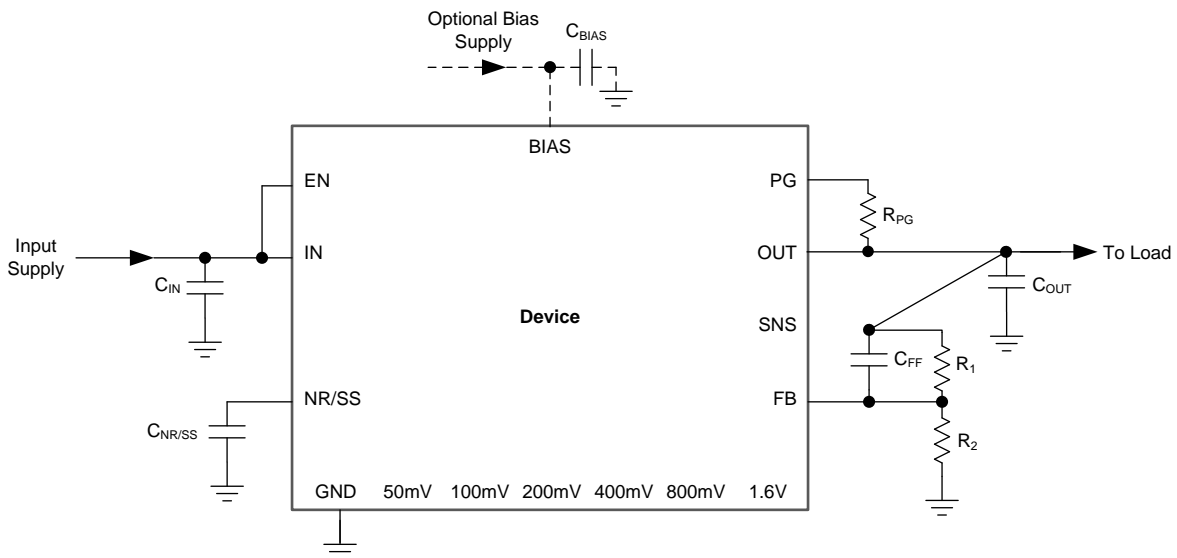
PARAMETER	DESIGN REQUIREMENT
Input voltage	5.60 V, ±1%, provided by the dc-dc converter switching at 500 kHz
Output voltage	5.0 V, ±1%
Output current	4.0 A (maximum), 10 mA (minimum)
Start-up time	< 25 ms

8.2.2.2 Detailed Design Procedure

For these conditions, the maximum dropout of the TPS7A85 is approximately 500 mV, thus a 600-mV headroom is sufficient for operation over both input and output voltage accuracy. At full load and high temperature on some devices, the TPS7A85 can enter dropout if both the input and output supply are beyond the edges of their accuracy specification.

For a 5.0-V output, use external adjustable resistors. See the resistor values in listed 表 5 for choosing resistors for a 5.0-V output.

Input and output capacitors are selected in accordance with the *Recommended Capacitor Types* section. Ceramic capacitances of 47 μF for the input and one 47-μF capacitor in parallel with two 10-μF capacitors for the output are selected. To further minimize noise, a feed-forward capacitance (C_{FF}) of 10 nF is selected.

To satisfy the required start-up time and still maintain low-noise performance, a 100-nF C_{NR/SS} is selected. This value is calculated with 公式 14.

$$t_{SS} = (V_{NR/SS} \times C_{NR/SS}) / I_{NR/SS} \tag{15}$$

The maximum ambient temperature for this application is 40°C based on 图 64 and given the 1% accuracy of the input supply. This temperature can still exceed the maximum junction temperature, but the 4.0-A load is a short pulse requirement and not a dc load so the thermal effects are minimal.

8.2.2.3 Application Curves

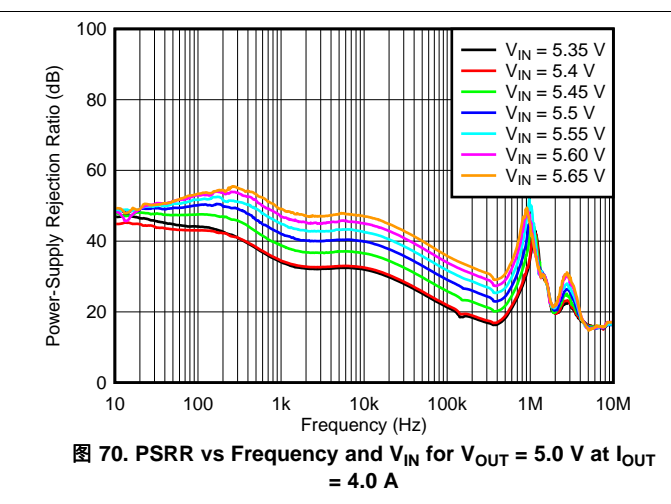
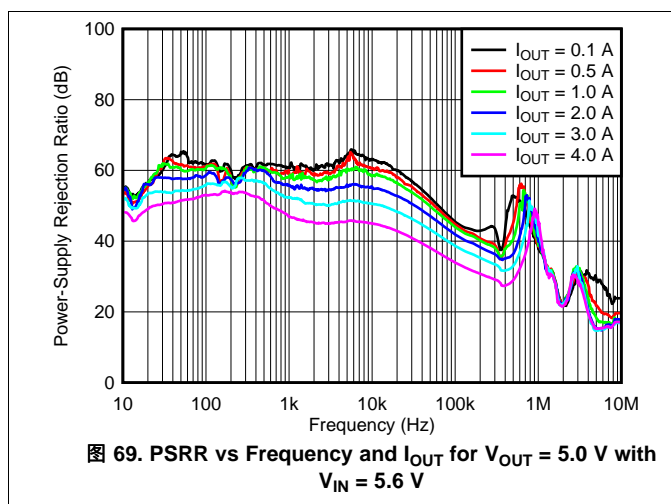

9 Power-Supply Recommendations

The TPS7A85 is designed to operate from an input voltage supply range between 1.1 V and 6.5 V. If the input supply is less than 1.4 V, then a bias rail of at least 3.0 V must be used. The input voltage range provides adequate headroom in order for the device to have a regulated output. This input supply must be well regulated. If the input supply is noisy, additional input capacitors with low ESR can help improve output noise performance.

10 Layout

10.1 Layout Guidelines

10.1.1 Board Layout

For best overall performance, place all circuit components on the same side of the circuit board and as near as practical to the respective LDO pin connections. Place ground return connections to the input and output capacitor, and to the LDO ground pin as close to each other as possible, connected by a wide, component-side, copper surface. The use of vias and long traces to the input and output capacitors is strongly discouraged and negatively affects system performance. The grounding and layout scheme shown in [图 71](#) minimizes inductive parasitics, and thereby reduces load-current transients, minimizes noise, and increases circuit stability.

A ground reference plane is also recommended and is either embedded in the PCB itself or located on the bottom side of the PCB opposite the components. This reference plane serves to assure accuracy of the output voltage, shield noise, and behaves similar to a thermal plane to spread (or sink) heat from the LDO device when connected to the thermal pad. In most applications, this ground plane is necessary to meet thermal requirements.

10.2 Layout Example



图 71. Example Layout

11 器件和文档支持

11.1 器件支持

11.1.1 开发支持

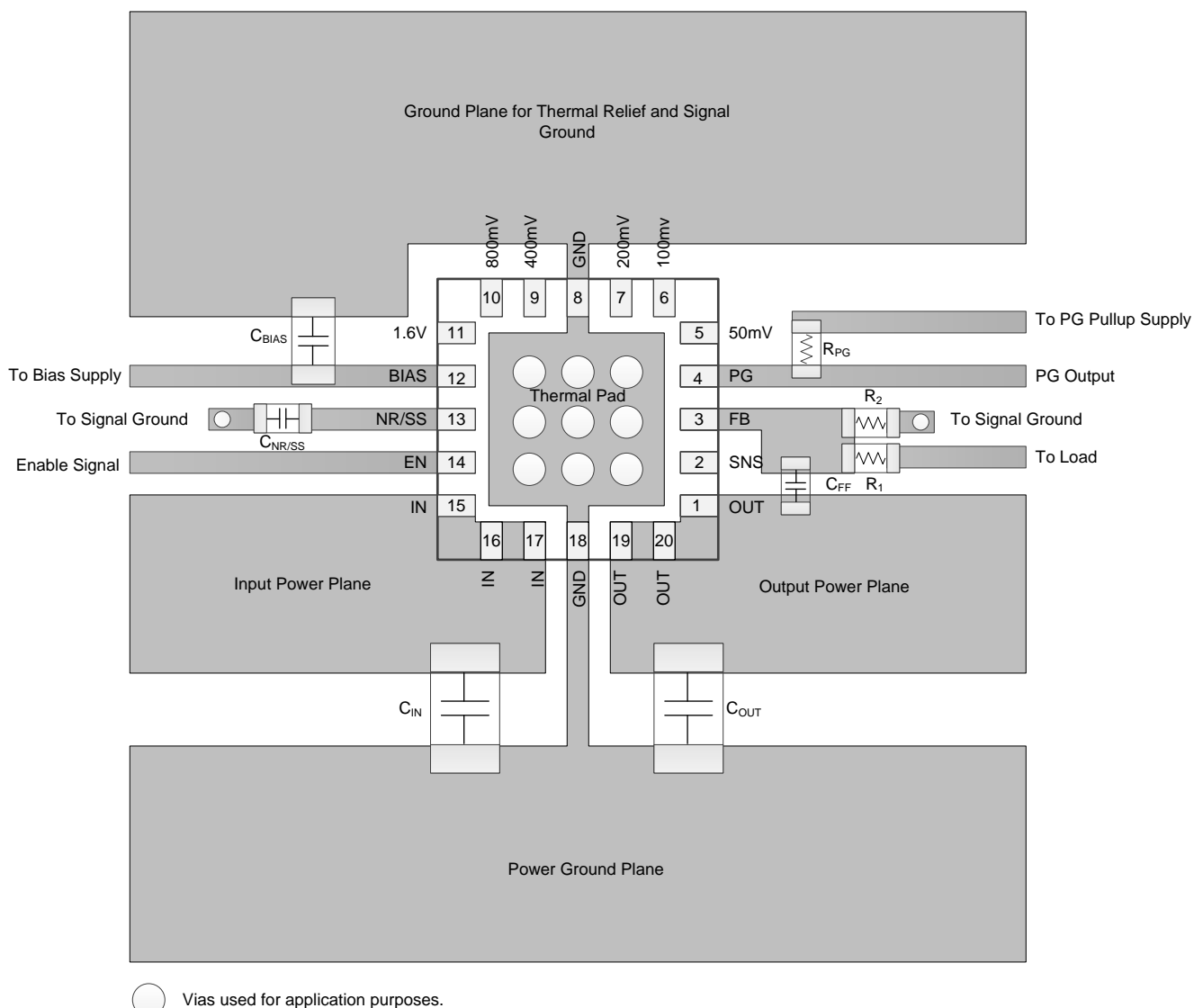
11.1.1.1 评估模块

评估模块 (EVM) 可与 TPS7A85 配套使用, 帮助评估初始电路性能。有关此固定装置的相关摘要信息, 请参见表 8。

表 8. 设计套件与评估模块

名称	文献编号
TPS7A8300EVM-209 评估模块	SLVU919
TPS7A8300EVM-579 评估模块	SBVU021

您可以在德州仪器 (TI) [网站](#)上的 TPS7A85 产品文件夹中获取 EVM。

11.1.1.2 Spice 模型

分析模拟电路和系统的性能时, 使用 SPICE 模型对电路性能进行计算机仿真非常有用。您可以从 TPS7A85 产品文件夹中的仿真模型下获取 TPS7A85 的 SPICE 模型。

11.1.2 器件命名规则

表 9. 订购信息⁽¹⁾

产品	说明
TPS7A85YYZ	YY 为封装标识符。 Z 为封装数量。

(1) 欲获得最新的封装和订货信息, 请参阅本文档末尾的封装选项附录, 或者访问 www.ti.com 查看器件产品文件夹。

11.2 文档支持

11.2.1 相关文档

相关文档如下:

- TPS3702 数据表, [SBVS251](#)
- TPS7A8300EVM-209 评估模块, [SLVU919](#)
- TPS7A8300EVM-579 评估模块, [SBVU021](#)
- TI LDO 应用手册的主题索引, [SBVA026](#)
- 使用前馈电容器和低压降稳压器的优缺点, [SBVA042](#)
- 6A 电流均流双路 LDO, [TIDU421](#)

11.3 社区资源

The following links connect to TI community resources. Linked contents are provided "AS IS" by the respective contributors. They do not constitute TI specifications and do not necessarily reflect TI's views; see TI's [Terms of Use](#).

TI E2E™ Online Community *TI's Engineer-to-Engineer (E2E) Community*. Created to foster collaboration among engineers. At e2e.ti.com, you can ask questions, share knowledge, explore ideas and help solve problems with fellow engineers.

Design Support *TI's Design Support* Quickly find helpful E2E forums along with design support tools and contact information for technical support.

11.4 商标

ANY-OUT, E2E are trademarks of Texas Instruments.
All other trademarks are the property of their respective owners.

11.5 静电放电警告



ESD 可能会损坏该集成电路。德州仪器 (TI) 建议通过适当的预防措施处理所有集成电路。如果不遵守正确的处理措施和安装程序，可能会损坏集成电路。

ESD 的损坏小至导致微小的性能降级，大至整个器件故障。精密的集成电路可能更容易受到损坏，这是因为非常细微的参数更改都可能会导致器件与其发布的规格不相符。

11.6 Glossary

[SLYZ022](#) — *TI Glossary*.

This glossary lists and explains terms, acronyms, and definitions.

12 机械、封装和可订购信息

以下页中包括机械、封装和可订购信息。这些信息是针对指定器件可提供的最新数据。这些数据会在无通知且不对本文档进行修订的情况下发生改变。欲获得该数据表的浏览器版本，请查阅左侧的导航栏。

重要声明

德州仪器(TI)及其下属子公司有权根据 JESD46 最新标准,对所提供的产品和服务进行更正、修改、增强、改进或其它更改,并有权根据 JESD48 最新标准中止提供任何产品和服务。客户在下订单前应获取最新的相关信息,并验证这些信息是否完整且是最新的。所有产品的销售都遵循在订单确认时所提供的TI 销售条款与条件。

TI 保证其所销售的组件的性能符合产品销售时 TI 半导体产品销售条件与条款的适用规范。仅在 TI 保证的范围内,且 TI 认为有必要时才会使用测试或其它质量控制技术。除非适用法律做出了硬性规定,否则没有必要对每种组件的所有参数进行测试。

TI 对应用帮助或客户产品设计不承担任何义务。客户应对其使用 TI 组件的产品和应用自行负责。为尽量减小与客户产品和应用相关的风险,客户应提供充分的设计与操作安全措施。

TI 不对任何 TI 专利权、版权、屏蔽作品权或其它与使用了 TI 组件或服务的组合设备、机器或流程相关的 TI 知识产权中授予的直接或隐含权限作出任何保证或解释。TI 所发布的与第三方产品或服务有关的信息,不能构成从 TI 获得使用这些产品或服务的许可、授权、或认可。使用此类信息可能需要获得第三方的专利权或其它知识产权方面的许可,或是 TI 的专利权或其它知识产权方面的许可。

对于 TI 的产品手册或数据表中 TI 信息的重要部分,仅在没有对内容进行任何篡改且带有相关授权、条件、限制和声明的情况下才允许进行复制。TI 对此类篡改过的文件不承担任何责任或义务。复制第三方的信息可能需要服从额外的限制条件。

在转售 TI 组件或服务时,如果对该组件或服务参数的陈述与 TI 标明的参数相比存在差异或虚假成分,则会失去相关 TI 组件或服务的所有明示或暗示授权,且这是不正当的、欺诈性商业行为。TI 对任何此类虚假陈述均不承担任何责任或义务。

客户认可并同意,尽管任何应用相关信息或支持仍可能由 TI 提供,但他们将独立负责满足与其产品及其在应用中使用的 TI 产品相关的所有法律、法规和安全相关要求。客户声明并同意,他们具备制定与实施安全措施所需的全部专业技术和知识,可预见故障的危险后果、监测故障及其后果、降低有可能造成人身伤害的故障的发生机率并采取适当的补救措施。客户将全额赔偿因在此类安全关键应用中使用任何 TI 组件而对 TI 及其代理造成的任何损失。

在某些场合中,为了推进安全相关应用有可能对 TI 组件进行特别的促销。TI 的目标是利用此类组件帮助客户设计和创立其特有的可满足适用的功能安全性标准和要求的终端产品解决方案。尽管如此,此类组件仍然服从这些条款。

TI 组件未获得用于 FDA Class III (或类似的生命攸关医疗设备)的授权许可,除非各方授权官员已经达成了专门管控此类使用的特别协议。

只有那些 TI 特别注明属于军用等级或“增强型塑料”的 TI 组件才是设计或专门用于军事/航空应用或环境的。购买者认可并同意,对并非指定面向军事或航空航天用途的 TI 组件进行军事或航空航天方面的应用,其风险由客户单独承担,并且由客户独立负责满足与此类使用相关的所有法律和法规要求。

TI 已明确指定符合 ISO/TS16949 要求的产品,这些产品主要用于汽车。在任何情况下,因使用非指定产品而无法达到 ISO/TS16949 要求, TI 不承担任何责任。

	产品		应用
数字音频	www.ti.com.cn/audio	通信与电信	www.ti.com.cn/telecom
放大器和线性器件	www.ti.com.cn/amplifiers	计算机及周边	www.ti.com.cn/computer
数据转换器	www.ti.com.cn/dataconverters	消费电子	www.ti.com.cn/consumer-apps
DLP® 产品	www.dlp.com	能源	www.ti.com.cn/energy
DSP - 数字信号处理器	www.ti.com.cn/dsp	工业应用	www.ti.com.cn/industrial
时钟和计时器	www.ti.com.cn/clockandtimers	医疗电子	www.ti.com.cn/medical
接口	www.ti.com.cn/interface	安防应用	www.ti.com.cn/security
逻辑	www.ti.com.cn/logic	汽车电子	www.ti.com.cn/automotive
电源管理	www.ti.com.cn/power	视频和影像	www.ti.com.cn/video
微控制器 (MCU)	www.ti.com.cn/microcontrollers		
RFID 系统	www.ti.com.cn/rfidsys		
OMAP应用处理器	www.ti.com/omap		
无线连通性	www.ti.com.cn/wirelessconnectivity	德州仪器在线技术支持社区	www.deyisupport.com

邮寄地址: 上海市浦东新区世纪大道1568号, 中建大厦32楼邮政编码: 200122
Copyright © 2016, 德州仪器半导体技术(上海)有限公司

PACKAGING INFORMATION

Orderable Device	Status (1)	Package Type	Package Drawing	Pins	Package Qty	Eco Plan (2)	Lead/Ball Finish (6)	MSL Peak Temp (3)	Op Temp (°C)	Device Marking (4/5)	Samples
TPS7A8500RGRR	ACTIVE	VQFN	RGR	20	3000	Green (RoHS & no Sb/Br)	CU NIPDAU	Level-2-260C-1 YEAR	-40 to 125	11DI	Samples
TPS7A8500RGRT	ACTIVE	VQFN	RGR	20	250	Green (RoHS & no Sb/Br)	CU NIPDAU	Level-2-260C-1 YEAR	-40 to 125	11DI	Samples

(1) The marketing status values are defined as follows:

ACTIVE: Product device recommended for new designs.

LIFEBUY: TI has announced that the device will be discontinued, and a lifetime-buy period is in effect.

NRND: Not recommended for new designs. Device is in production to support existing customers, but TI does not recommend using this part in a new design.

PREVIEW: Device has been announced but is not in production. Samples may or may not be available.

OBSOLETE: TI has discontinued the production of the device.

(2) Eco Plan - The planned eco-friendly classification: Pb-Free (RoHS), Pb-Free (RoHS Exempt), or Green (RoHS & no Sb/Br) - please check <http://www.ti.com/productcontent> for the latest availability information and additional product content details.

TBD: The Pb-Free/Green conversion plan has not been defined.

Pb-Free (RoHS): TI's terms "Lead-Free" or "Pb-Free" mean semiconductor products that are compatible with the current RoHS requirements for all 6 substances, including the requirement that lead not exceed 0.1% by weight in homogeneous materials. Where designed to be soldered at high temperatures, TI Pb-Free products are suitable for use in specified lead-free processes.

Pb-Free (RoHS Exempt): This component has a RoHS exemption for either 1) lead-based flip-chip solder bumps used between the die and package, or 2) lead-based die adhesive used between the die and leadframe. The component is otherwise considered Pb-Free (RoHS compatible) as defined above.

Green (RoHS & no Sb/Br): TI defines "Green" to mean Pb-Free (RoHS compatible), and free of Bromine (Br) and Antimony (Sb) based flame retardants (Br or Sb do not exceed 0.1% by weight in homogeneous material)

(3) MSL, Peak Temp. - The Moisture Sensitivity Level rating according to the JEDEC industry standard classifications, and peak solder temperature.

(4) There may be additional marking, which relates to the logo, the lot trace code information, or the environmental category on the device.

(5) Multiple Device Markings will be inside parentheses. Only one Device Marking contained in parentheses and separated by a "~" will appear on a device. If a line is indented then it is a continuation of the previous line and the two combined represent the entire Device Marking for that device.

(6) Lead/Ball Finish - Orderable Devices may have multiple material finish options. Finish options are separated by a vertical ruled line. Lead/Ball Finish values may wrap to two lines if the finish value exceeds the maximum column width.



Important Information and Disclaimer: The information provided on this page represents TI's knowledge and belief as of the date that it is provided. TI bases its knowledge and belief on information provided by third parties, and makes no representation or warranty as to the accuracy of such information. Efforts are underway to better integrate information from third parties. TI has taken and continues to take reasonable steps to provide representative and accurate information but may not have conducted destructive testing or chemical analysis on incoming materials and chemicals. TI and TI suppliers consider certain information to be proprietary, and thus CAS numbers and other limited information may not be available for release.

In no event shall TI's liability arising out of such information exceed the total purchase price of the TI part(s) at issue in this document sold by TI to Customer on an annual basis.

RGR (S-PVQFN-N20)

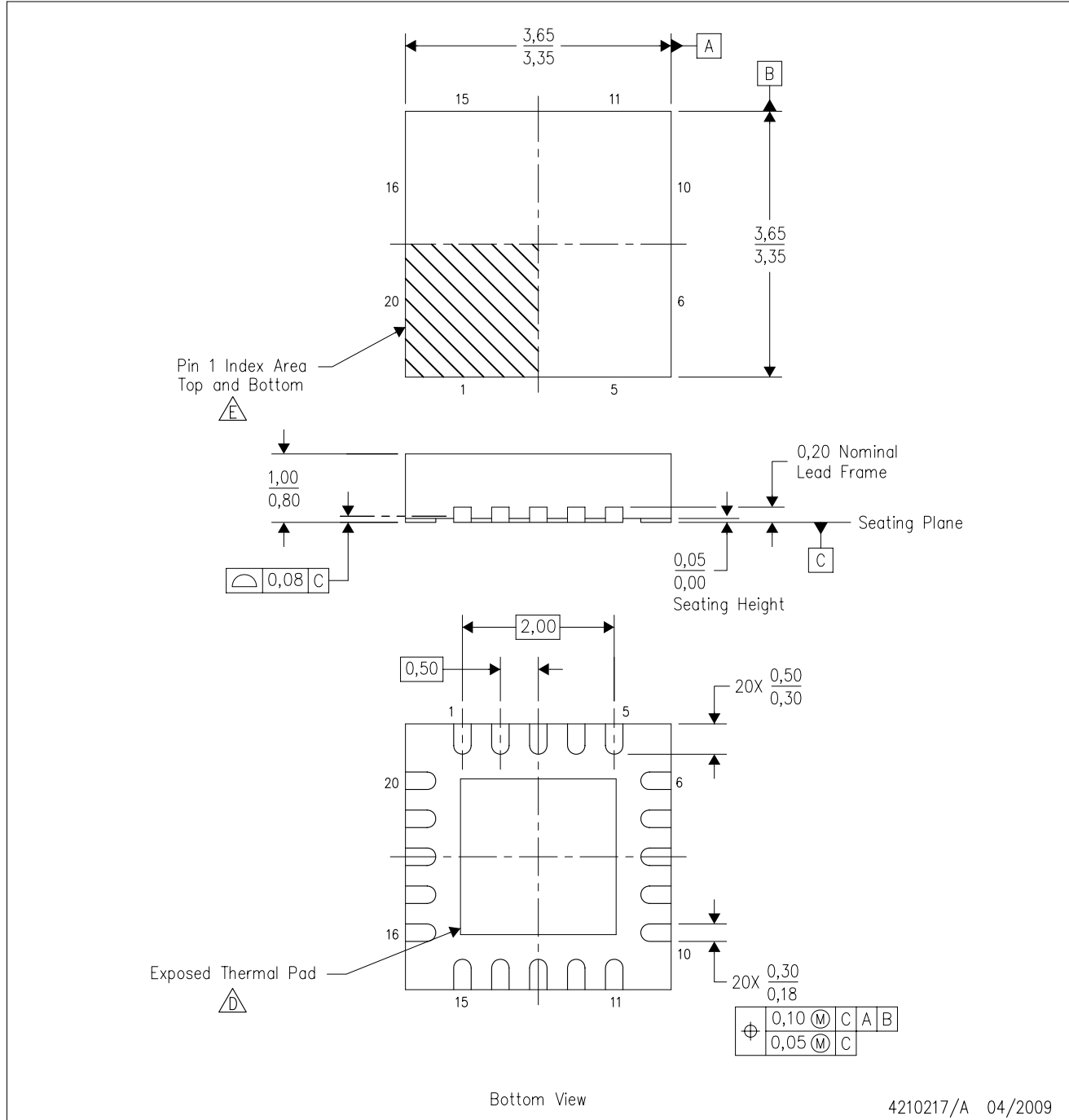
PLASTIC QUAD FLATPACK NO-LEAD



- NOTES:
- A. All linear dimensions are in millimeters. Dimensioning and tolerancing per ASME Y14.5M-1994.
 - B. This drawing is subject to change without notice.
 - C. QFN (Quad Flatpack No-Lead) package configuration.
 -  The package thermal pad must be soldered to the board for thermal and mechanical performance. See the Product Data Sheet for details regarding the exposed thermal pad dimensions.
 -  Pin 1 identifiers are located on both top and bottom of the package and within the zone indicated. The Pin 1 identifiers are either a molded, marked, or metal feature.

THERMAL PAD MECHANICAL DATA

RGR (S-PVQFN-N20)

PLASTIC QUAD FLATPACK NO-LEAD

THERMAL INFORMATION

This package incorporates an exposed thermal pad that is designed to be attached directly to an external heatsink. The thermal pad must be soldered directly to the printed circuit board (PCB). After soldering, the PCB can be used as a heatsink. In addition, through the use of thermal vias, the thermal pad can be attached directly to the appropriate copper plane shown in the electrical schematic for the device, or alternatively, can be attached to a special heatsink structure designed into the PCB. This design optimizes the heat transfer from the integrated circuit (IC).

For information on the Quad Flatpack No-Lead (QFN) package and its advantages, refer to Application Report, QFN/SON PCB Attachment, Texas Instruments Literature No. SLUA271. This document is available at www.ti.com.

The exposed thermal pad dimensions for this package are shown in the following illustration.

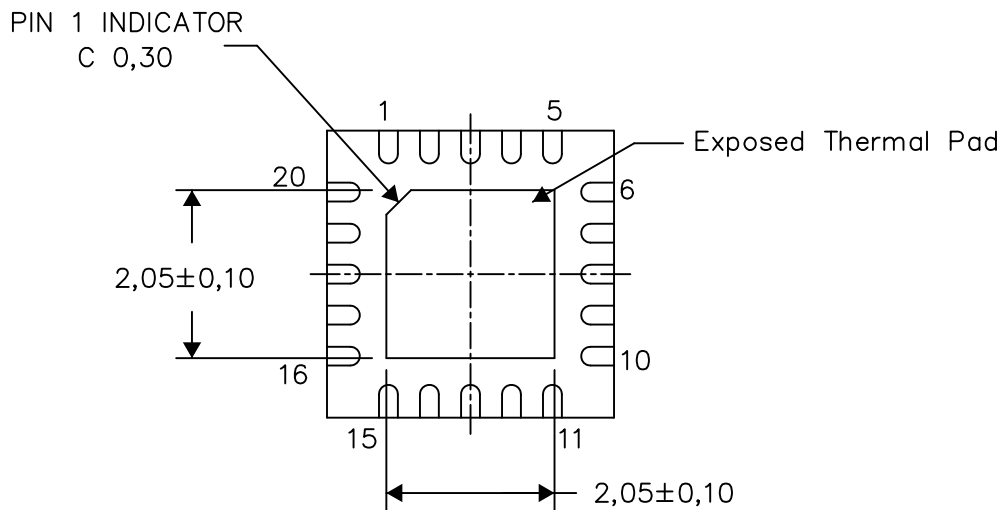

Bottom View

Exposed Thermal Pad Dimensions

4210218/E 04/14

NOTE: All linear dimensions are in millimeters

RGR (S-PVQFN-N20)

PLASTIC QUAD FLATPACK NO-LEAD

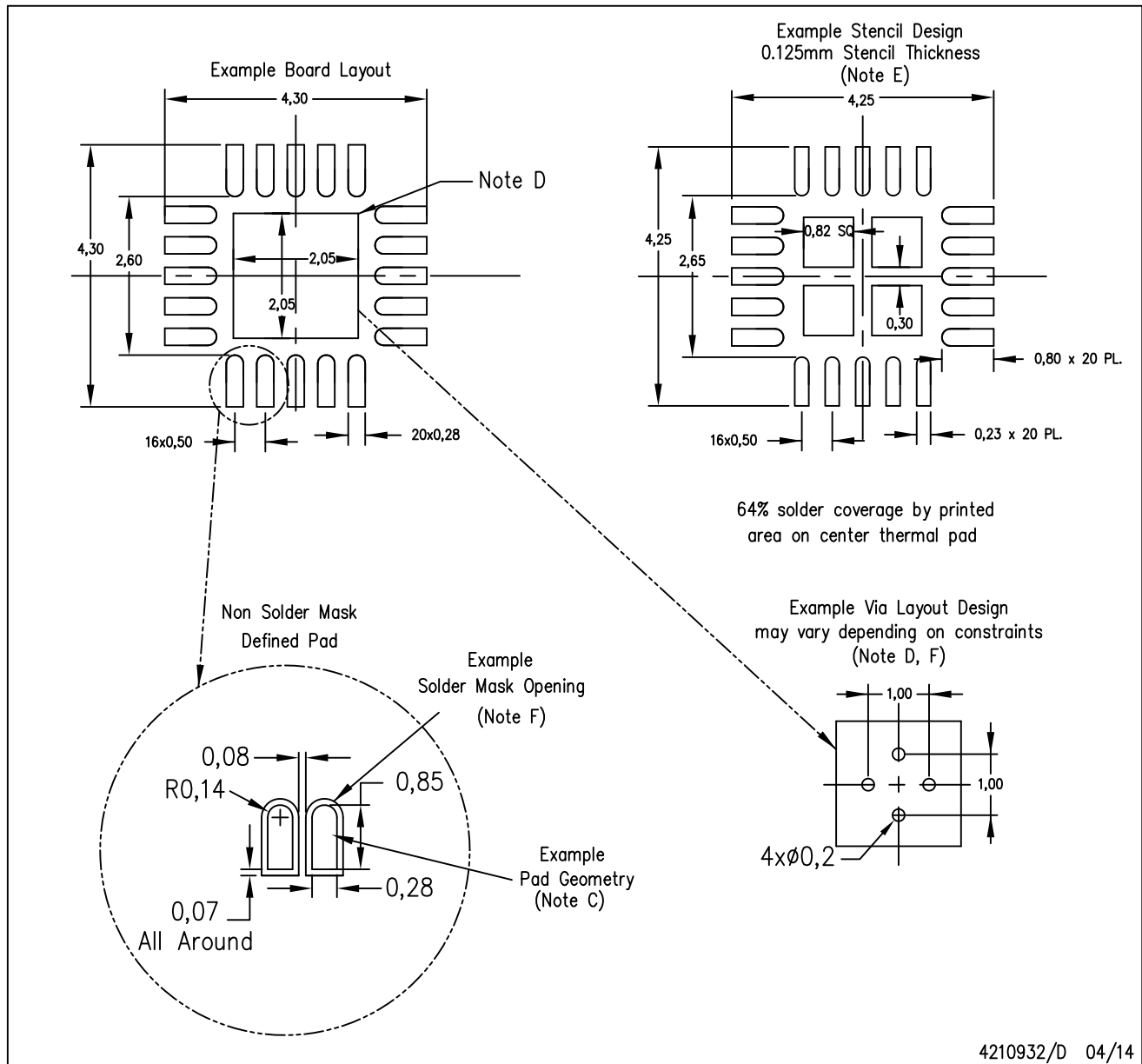

4210932/D 04/14

- NOTES:
- All linear dimensions are in millimeters.
 - This drawing is subject to change without notice.
 - Publication IPC-7351 is recommended for alternate designs.
 - This package is designed to be soldered to a thermal pad on the board. Refer to Application Note, Quad Flat-Pack QFN/SON PCB Attachment, Texas Instruments Literature No. SLUA271, and also the Product Data Sheets for specific thermal information, via requirements, and recommended board layout. These documents are available at www.ti.com <<http://www.ti.com>>.
 - Laser cutting apertures with trapezoidal walls and also rounding corners will offer better paste release. Customers should contact their board assembly site for stencil design recommendations. Refer to IPC 7525 for stencil design considerations.
 - Customers should contact their board fabrication site for minimum solder mask web tolerances between signal pads.

重要声明和免责声明

TI 均以“原样”提供技术性数据（包括数据表）、设计资源（包括参考设计）、应用或其他设计建议、网络工具、安全信息和其他资源，不保证其中不含任何瑕疵，且不做任何明示或暗示的担保，包括但不限于对适销性、适合某特定用途或不侵犯任何第三方知识产权的暗示担保。

所述资源可供专业开发人员应用TI 产品进行设计使用。您将对以下行为独自承担全部责任：(1) 针对您的应用选择合适的TI 产品；(2) 设计、验证并测试您的应用；(3) 确保您的应用满足相应标准以及任何其他安全、安保或其他要求。所述资源如有变更，恕不另行通知。TI 对您使用所述资源的授权仅限于开发资源所涉及TI 产品的相关应用。除此之外不得复制或展示所述资源，也不提供其它TI 或任何第三方的知识产权授权许可。如因使用所述资源而产生任何索赔、赔偿、成本、损失及债务等，TI 对此概不负责，并且您须赔偿由此对TI 及其代表造成的损害。

TI 所提供产品均受TI 的销售条款 (<http://www.ti.com.cn/zh-cn/legal/termsofsale.html>) 以及ti.com.cn上或随附TI产品提供的其他可适用条款的约束。TI提供所述资源并不扩展或以其他方式更改TI 针对TI 产品所发布的可适用的担保范围或担保免责声明。

邮寄地址：上海市浦东新区世纪大道 1568 号中建大厦 32 楼，邮政编码：200122
Copyright © 2019 德州仪器半导体技术（上海）有限公司