



Heterojunction Bipolar Transistor Technology (InGaP HBT)

Broadband High Linearity Amplifier

The MMG3005NT1 is a General Purpose Amplifier that is internally prematched and designed for a broad range of Class A, small-signal, high linearity, general purpose applications. It is suitable for applications with frequencies from 800 to 2200 MHz such as Cellular, PCS, WLL, PHS, VHF, UHF, UMTS and general small-signal RF.

Features

- Frequency: 800-2200 MHz
- P1dB: 30 dBm @ 2140 MHz
- Small-Signal Gain: 15 dB @ 2140 MHz
- Third Order Output Intercept Point: 47 dBm @ 2140 MHz
- Single 5 Volt Supply
- Internally Prematched to 50 Ohms
- Pb-Free Leads. RoHS Compliant.
- In Tape and Reel. T1 Suffix = 1000 Units per 12 mm, 7 inch Reel.

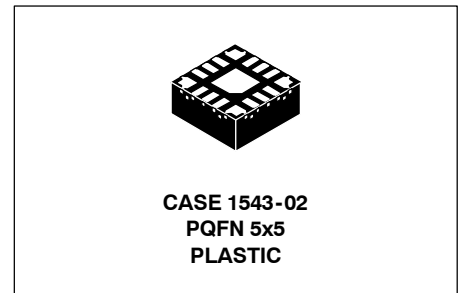

Table 1. Typical Performance (1)

Characteristic	Symbol	900 MHz	1960 MHz	2140 MHz	Unit
Small-Signal Gain (S21)	G _p	18.5	15.5	15	dB
Input Return Loss (S11)	IRL	-14	-10	-11	dB
Output Return Loss (S22)	ORL	-12	-7	-7	dB
Power Output @1dB Compression	P1db	30	30	30	dBm
Third Order Output Intercept Point	IP3	47	47	47	dBm

1. V_{DC} = 5 Vdc, T_C = 25°C, 50 ohm system

Table 2. Maximum Ratings

Rating	Symbol	Value	Unit
Supply Voltage (2)	V _{DC}	6	V
Supply Current (2)	I _{DC}	600	mA
RF Input Power	P _{in}	18	dBm
Storage Temperature Range	T _{stg}	-65 to +150	°C
Junction Temperature (3)	T _J	150	°C

2. Continuous voltage and current applied to device.

3. For reliable operation, the junction temperature should not exceed 150°C.

Table 3. Thermal Characteristics (V_{DC} = 5 Vdc, I_{DC} = 480 mA, T_C = 25°C)

Characteristic	Symbol	Value (4)	Unit
Thermal Resistance, Junction to Case	R _{θJC}	21.5	°C/W

4. Refer to AN1955, *Thermal Measurement Methodology of RF Power Amplifiers*. Go to <http://www.freescale.com/rf>. Select Documentation/Application Notes - AN1955.

Table 4. Electrical Characteristics ($V_{DC} = 5 \text{ Vdc}$, 2140 MHz, $T_C = 25^\circ\text{C}$, 50 ohm system, in Freescale Application Circuit)

Characteristic	Symbol	Min	Typ	Max	Unit
Small-Signal Gain (S21)	G_p	14	15	—	dB
Input Return Loss (S11)	IRL	—	-11	—	dB
Output Return Loss (S22)	ORL	—	-7	—	dB
Power Output @ 1dB Compression	P1dB	—	30	—	dBm
Third Order Output Intercept Point	IP3	—	47	—	dBm
Noise Figure	NF	—	5	—	dB
Supply Current (1)	I_{DC}	455	480	520	mA
Supply Voltage (1)	V_{DC}	—	5	—	V

1. For reliable operation, the junction temperature should not exceed 150°C .

Table 5. Functional Pin Description

Name	Pin Number	Description
RF _{in}	3, 4	RF input for the power amplifier. This pin is DC-coupled and requires a DC-blocking series capacitor.
RF _{OUT} / V _{CC}	10, 11, 12	RF output for the power amplifier. This pin is DC-coupled and requires a DC-blocking series capacitor.
V _{CC}	14	Collector voltage supply.
V _{BA}	16	Bias voltage supply.
GND	Backside Center Metal	The center metal base of the PQFN package provides both DC and RF ground as well as heat sink contact for the power amplifier.

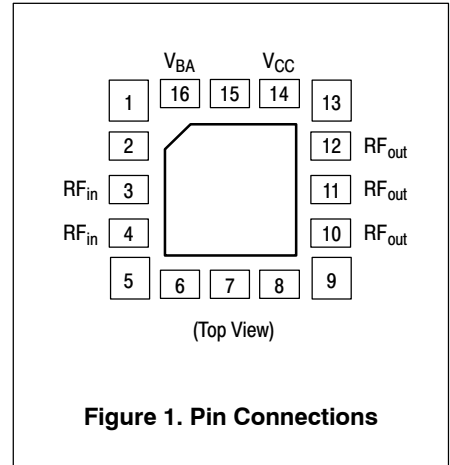

Table 6. ESD Protection Characteristics

Test Methodology	Class
Human Body Model (per JESD 22-A114)	1A (Minimum)
Machine Model (per EIA/JESD 22-A115)	A (Minimum)
Charge Device Model (per JESD 22-C101)	IV (Minimum)

Table 7. Moisture Sensitivity Level

Test Methodology	Rating	Package Peak Temperature	Unit
Per JESD 22-A113, IPC/JEDEC J-STD-020	3	260	°C

50 OHM TYPICAL CHARACTERISTICS

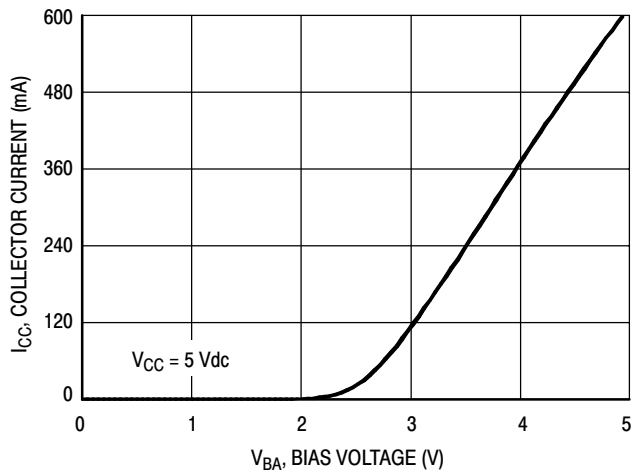
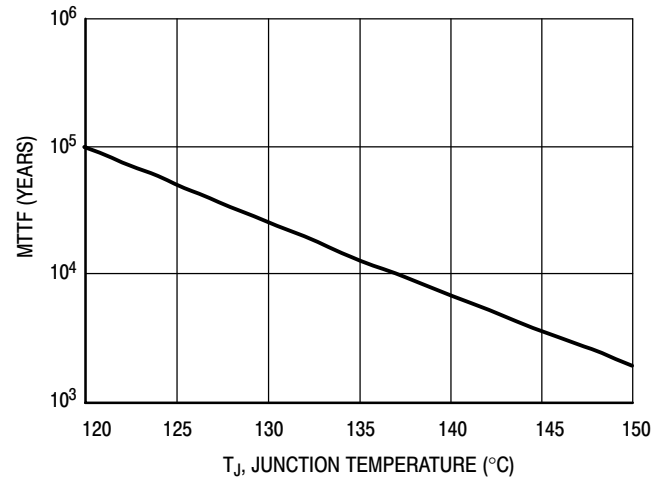

Figure 2. Collector Current versus Bias Voltage



NOTE: The MTTF is calculated with $V_{DC} = 5$ Vdc, $I_{DC} = 480$ mA

Figure 3. MTTF versus Junction Temperature

50 OHM APPLICATION CIRCUIT: 900 MHz

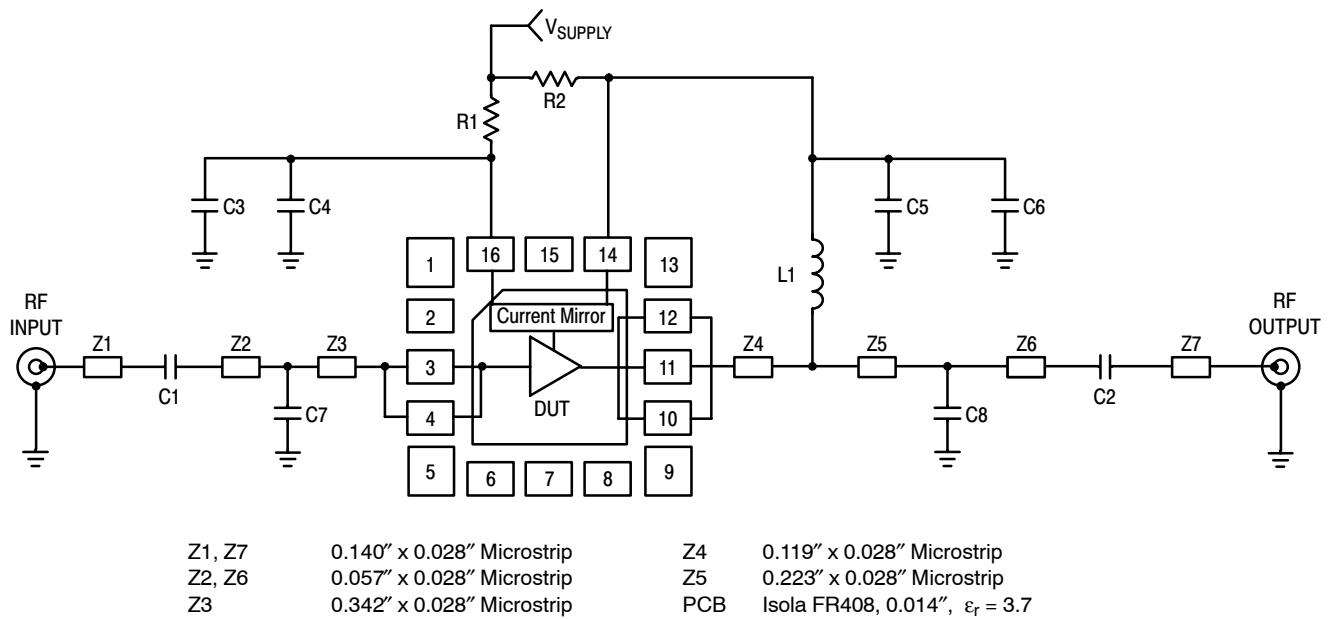

Figure 4. 50 Ohm Test Circuit Schematic

Table 8. 50 Ohm Test Circuit Component Designations and Values

Part	Description	Part Number	Manufacturer
C1, C2	15 pF Chip Capacitors	ECUV1H150JCV	Panasonic
C3, C5	0.01 μ F Chip Capacitors	0603A103JAT2A	AVX
C4, C6	0.1 μ F Chip Capacitors	0603A102JAT2A	AVX
C7	6.8 pF Chip Capacitor	06035J6R8BBT	AVX
C8	5.6 pF Chip Capacitor	06035J5R6BBT	AVX
L1	15 nH Chip Inductor	1008CS-150XJB	Coilcraft
R1	33 Ω Chip Resistor		
R2	0 Ω Chip Resistor		

50 OHM APPLICATION CIRCUIT: 900 MHz

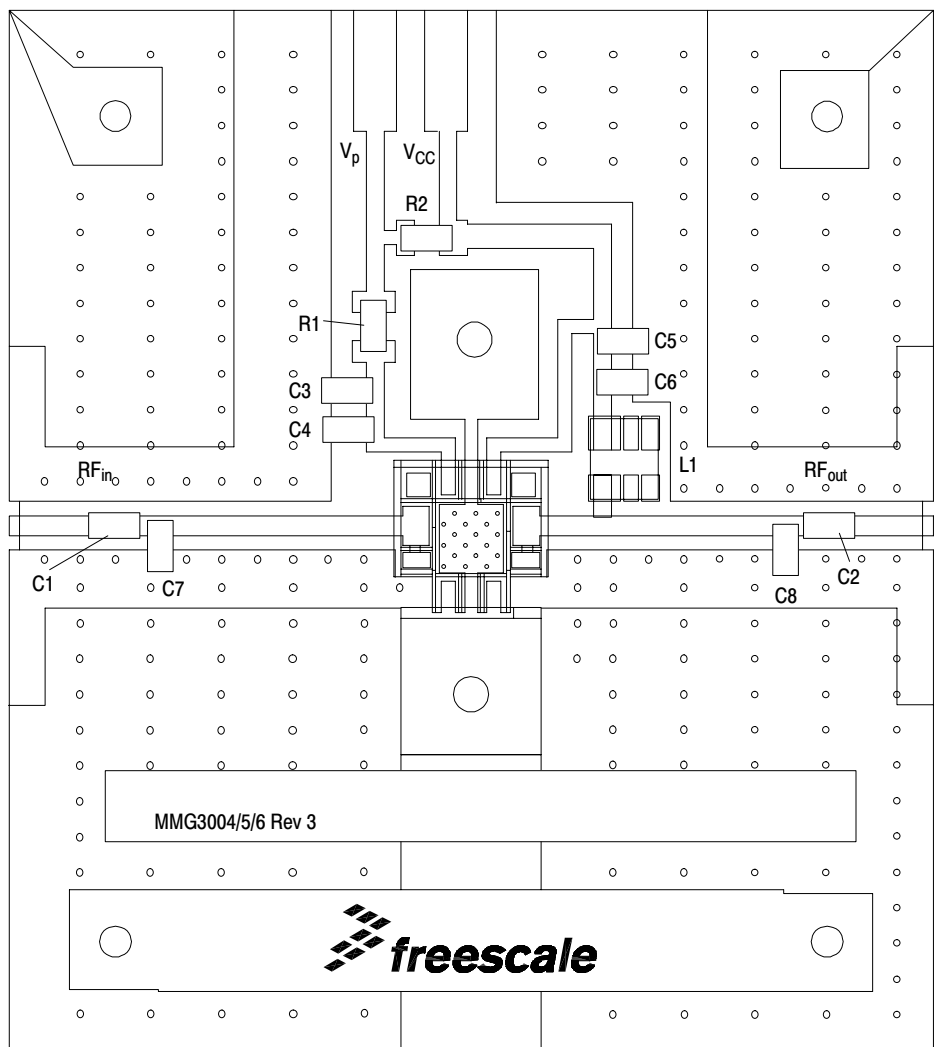

Figure 5. 50 Ohm Test Circuit Component Layout

50 OHM TYPICAL CHARACTERISTICS: 900 MHz

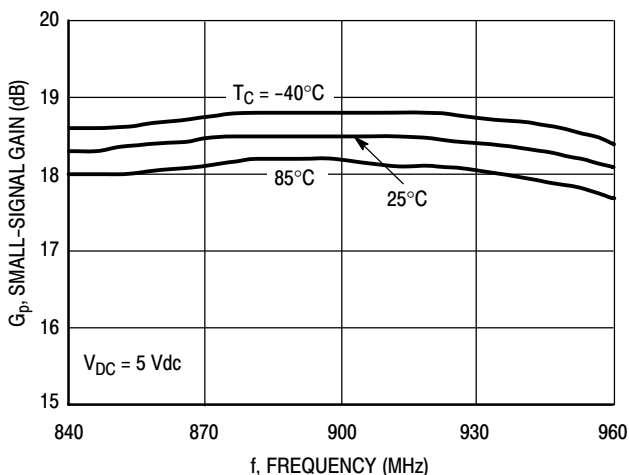

Figure 6. Small-Signal Gain (S21) versus Frequency

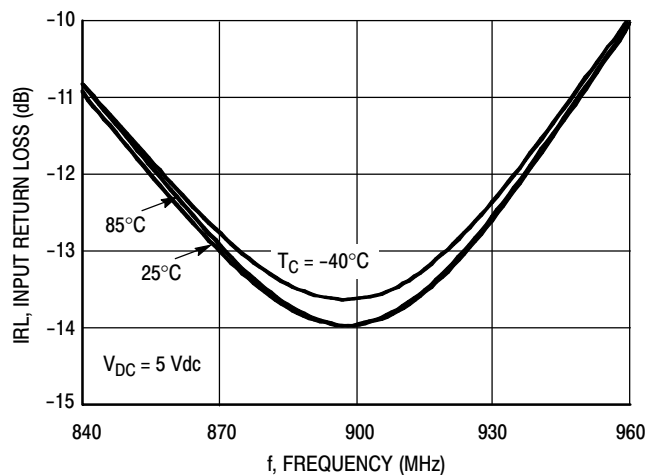

Figure 7. Input Return Loss (S11) versus Frequency

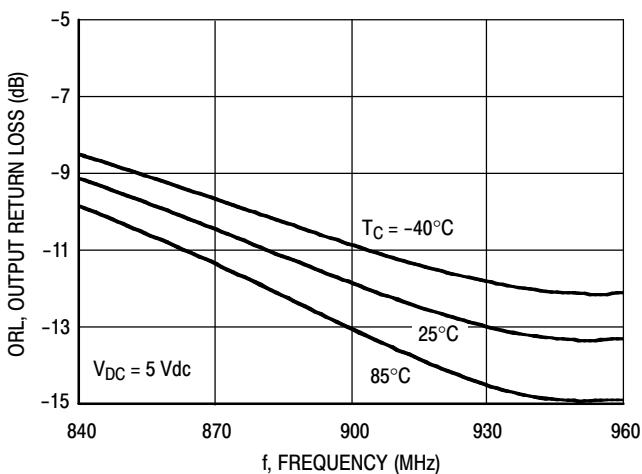

Figure 8. Output Return Loss (S22) versus Frequency

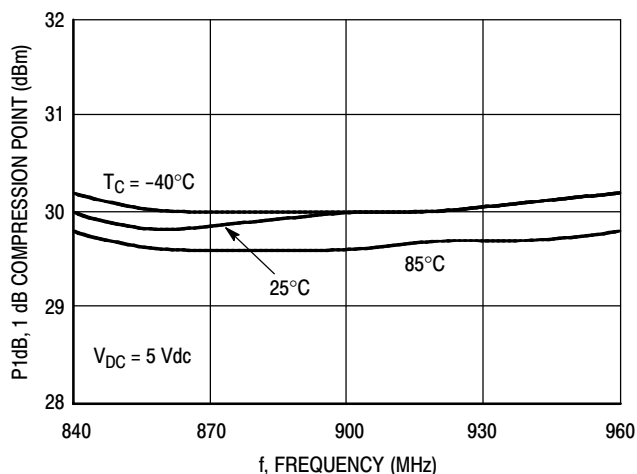

Figure 9. P1dB versus Frequency

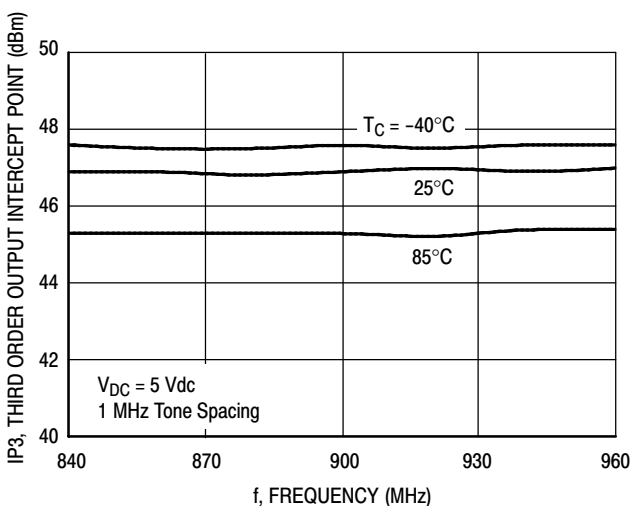

Figure 10. Third Order Output Intercept Point versus Frequency

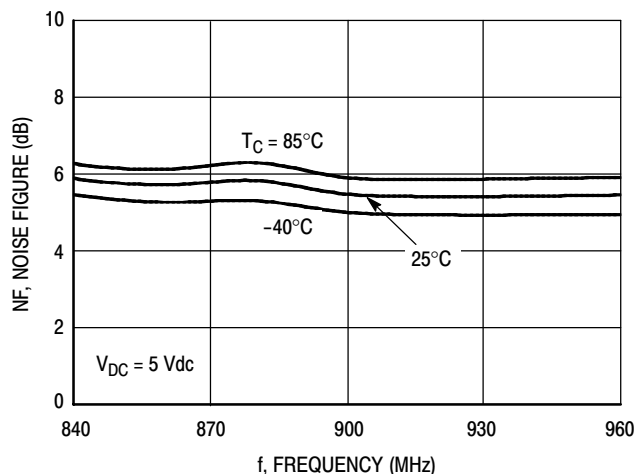

Figure 11. Noise Figure versus Frequency

50 OHM TYPICAL CHARACTERISTICS: 900 MHz

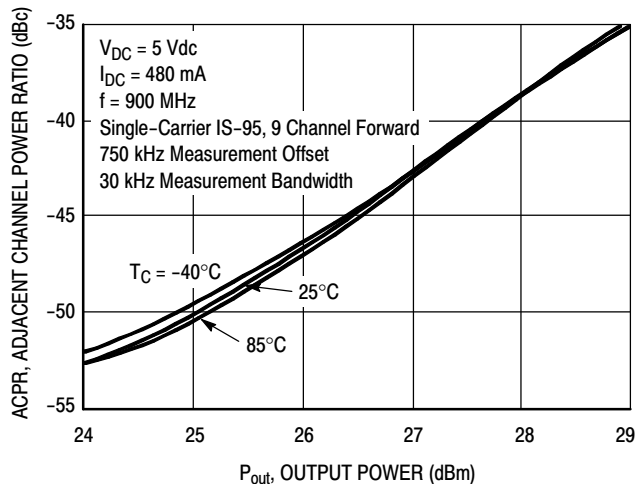

Figure 12. IS-95 Adjacent Channel Power Ratio versus Output Power

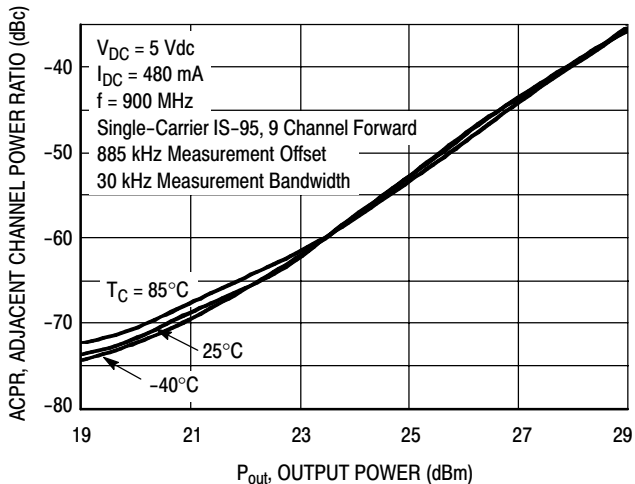

Figure 13. IS-95 Adjacent Channel Power Ratio versus Output Power

50 OHM APPLICATION CIRCUIT: 1800-2200 MHz

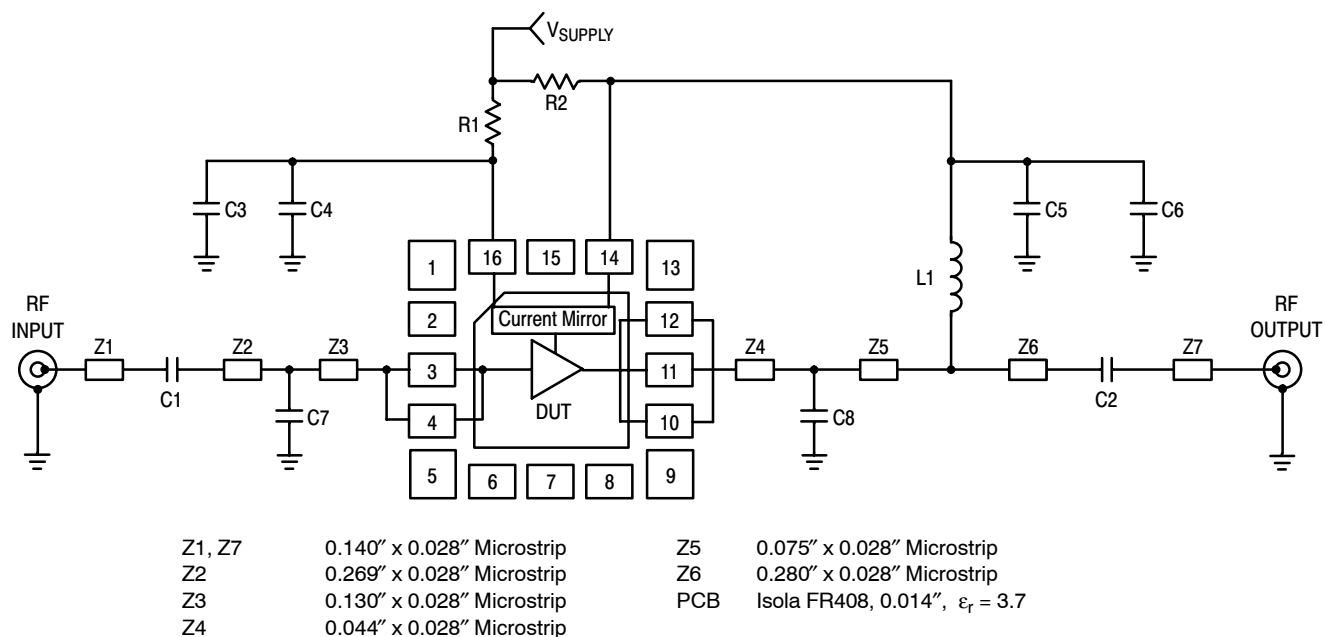

Figure 14. 50 Ohm Test Circuit Schematic

Table 9. 50 Ohm Test Circuit Component Designations and Values

Part	Description	Part Number	Manufacturer
C1	15 pF Chip Capacitor	ECUV1H150JCV	Panasonic
C2	1.8 pF Chip Capacitor	06035J1R8BBT	AVX
C3, C5	0.01 μ F Chip Capacitors	0603A103JAT2A	AVX
C4, C6	0.1 μ F Chip Capacitors	0603A102JAT2A	AVX
C7	2.7 pF Chip Capacitor	06035J2R7BBT	AVX
C8	1.2 pF Chip Capacitor	06035J1R2BBT	AVX
L1	15 nH Chip Inductor	1008CS-150XJB	Coilcraft
R1	33 Ω Chip Resistor		
R2	0 Ω Chip Resistor		

50 OHM APPLICATION CIRCUIT: 1800-2200 MHz

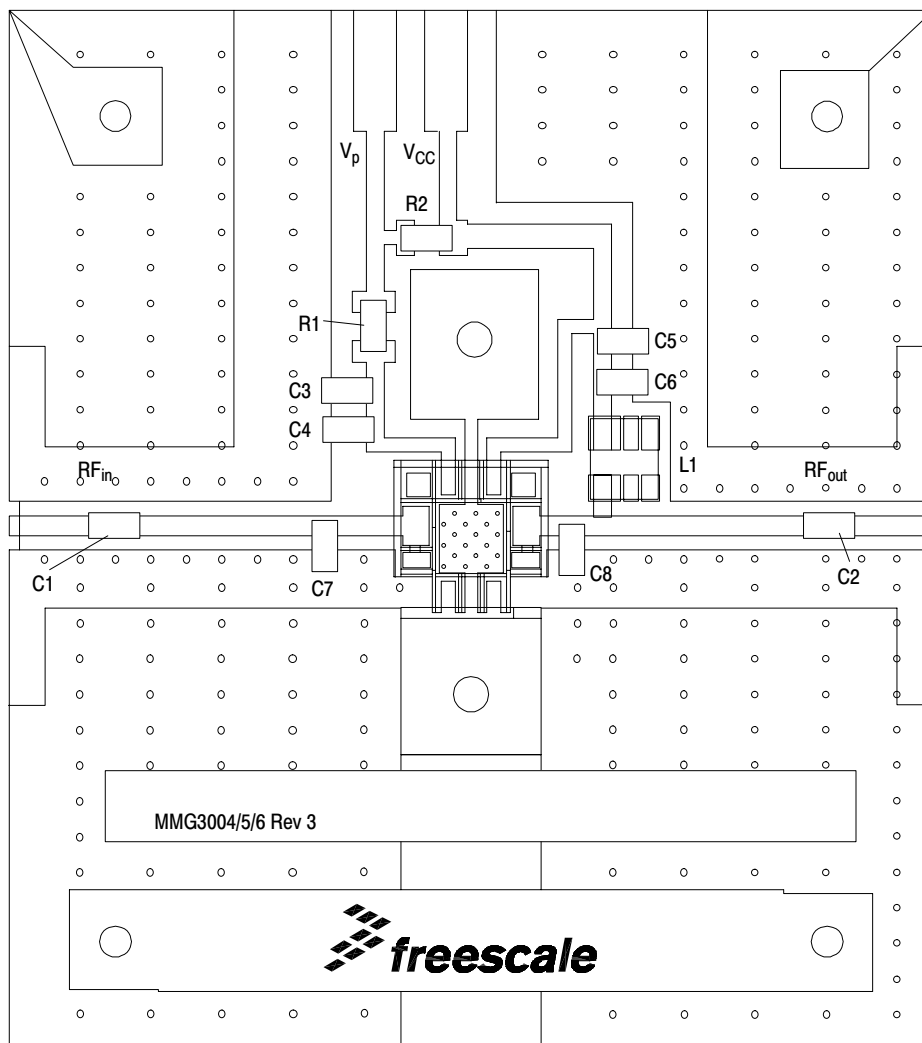

Figure 15. 50 Ohm Test Circuit Component Layout

50 OHM TYPICAL CHARACTERISTICS: 1800-2200 MHz

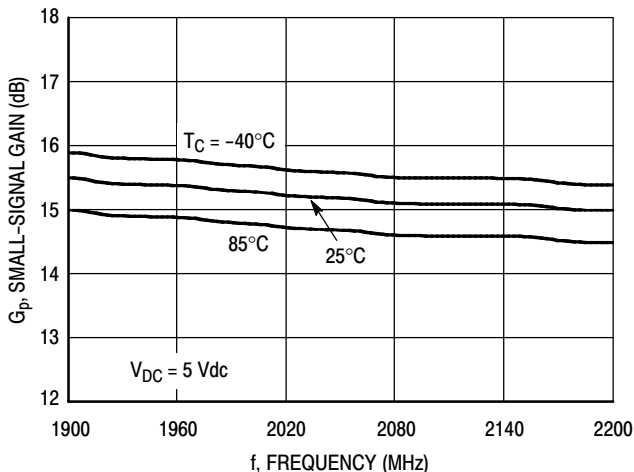

Figure 16. Small-Signal Gain (S21) versus Frequency

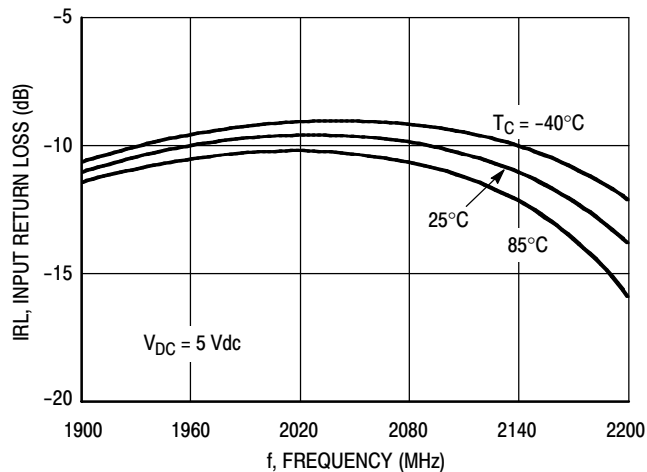

Figure 17. Input Return Loss (S11) versus Frequency

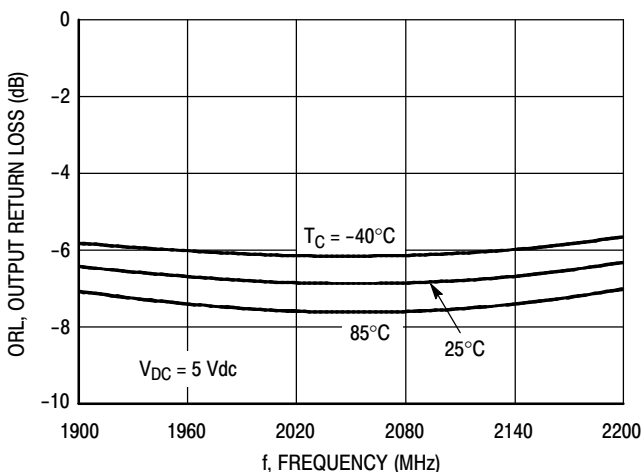

Figure 18. Output Return Loss (S22) versus Frequency

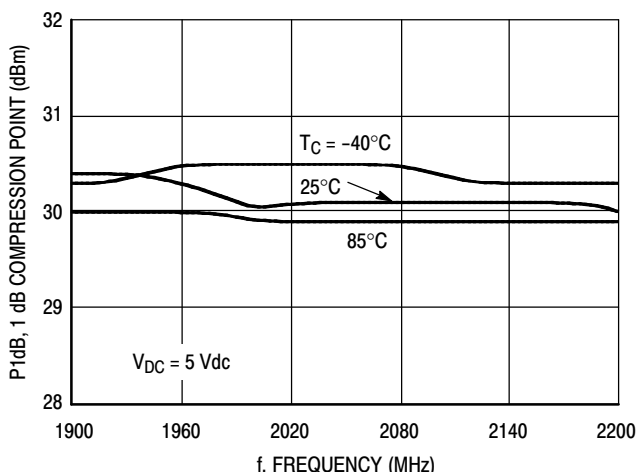

Figure 19. P1dB versus Frequency

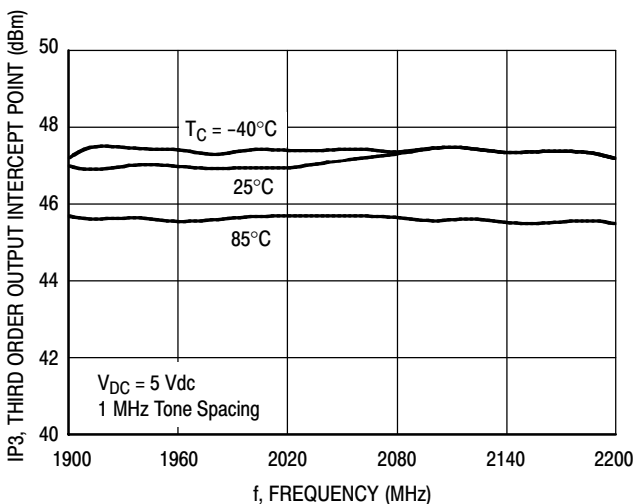

Figure 20. Third Order Output Intercept Point versus Frequency

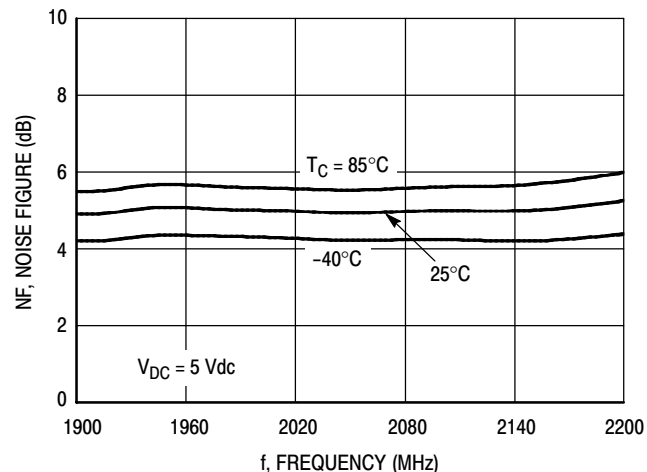

Figure 21. Noise Figure versus Frequency

50 OHM TYPICAL CHARACTERISTICS: 1800-2200 MHz

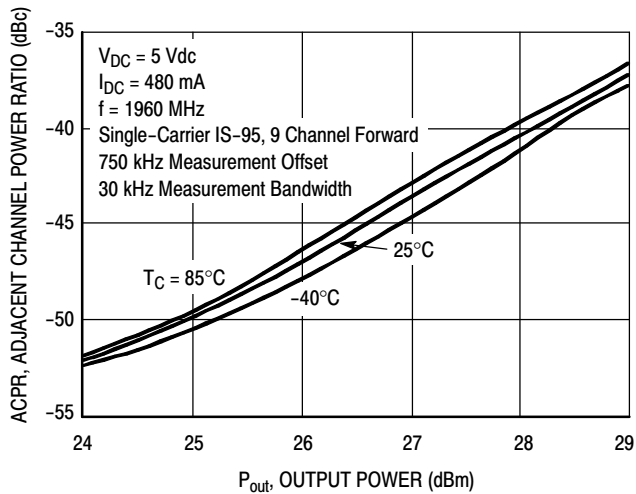

Figure 22. IS-95 Adjacent Channel Power Ratio versus Output Power

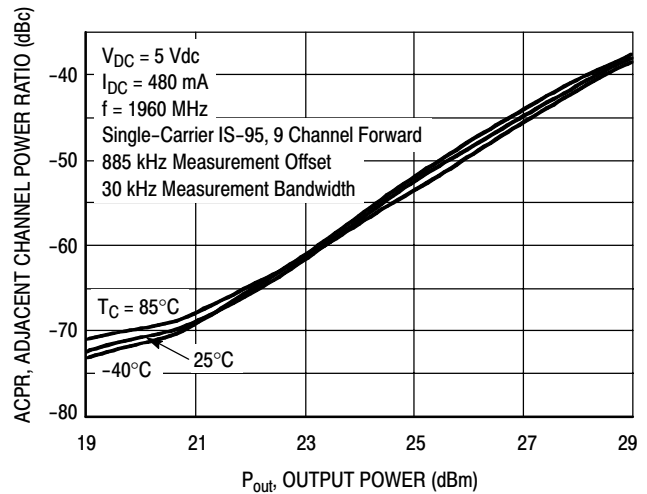

Figure 23. IS-95 Adjacent Channel Power Ratio versus Output Power

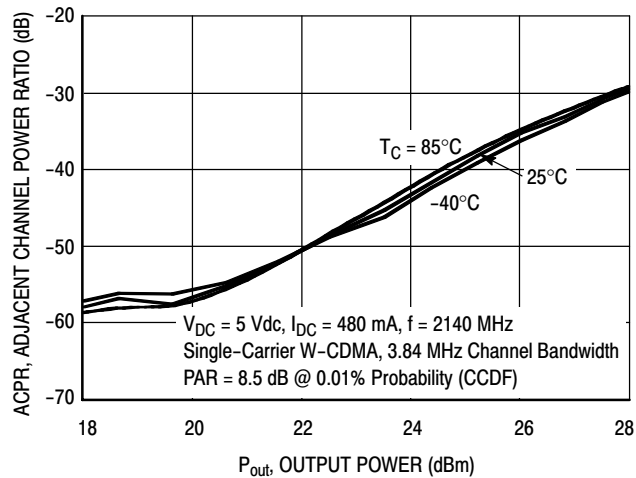

Figure 24. Single-Carrier W-CDMA Adjacent Channel Power Ratio versus Output Power

50 OHM TYPICAL CHARACTERISTICS

Table 10. Class A Common Emitter S-Parameters at $V_{DC} = 5 \text{ Vdc}$, $I_{DC} = 480 \text{ mA}$, $T_C = 25^\circ\text{C}$

f GHz	S ₁₁		S ₂₁		S ₁₂		S ₂₂	
	S ₁₁	∠φ	S ₂₁	∠φ	S ₁₂	∠φ	S ₂₂	∠φ
0.25	0.70575	-173.81	5.06022	143.91	0.00976	-49.75	0.84913	174.65
0.3	0.73140	-174.91	4.79122	137.40	0.00866	-46.60	0.84273	173.16
0.35	0.75442	-176.26	4.52885	131.51	0.00773	-43.76	0.83759	172.12
0.4	0.77553	-177.67	4.27831	126.11	0.00689	-40.58	0.83409	171.28
0.45	0.79364	-179.04	4.03762	121.18	0.00618	-36.61	0.83042	170.63
0.5	0.80933	179.58	3.82617	116.75	0.00565	-31.68	0.83214	170.43
0.55	0.82301	178.27	3.62033	112.46	0.00523	-26.34	0.83079	169.99
0.6	0.83429	177.07	3.43310	108.55	0.00494	-20.59	0.82956	169.83
0.65	0.84357	175.98	3.26377	104.82	0.00478	-15.13	0.82812	169.78
0.7	0.85132	174.99	3.10735	101.29	0.00468	-10.28	0.82590	169.86
0.75	0.85696	174.16	2.96322	97.96	0.00459	-5.76	0.82489	170.15
0.8	0.86176	173.35	2.82568	94.86	0.00454	-1.51	0.82589	170.57
0.85	0.86572	172.60	2.70160	92.31	0.00452	3.52	0.82783	171.07
0.9	0.86813	171.85	2.60468	90.11	0.00455	7.99	0.83010	171.50
0.95	0.86945	171.15	2.53732	88.04	0.00475	12.64	0.83192	172.00
1	0.86974	170.42	2.48944	85.86	0.00498	15.23	0.83202	172.45
1.05	0.86842	169.66	2.45821	83.61	0.00517	16.96	0.83128	172.96
1.1	0.86533	168.91	2.44429	81.27	0.00537	18.37	0.82923	173.50
1.15	0.86095	168.14	2.44811	78.81	0.00562	19.48	0.82679	174.01
1.2	0.85480	167.25	2.46595	76.18	0.00589	19.73	0.82313	174.63
1.25	0.84684	166.25	2.49650	73.39	0.00614	19.47	0.81800	175.29
1.3	0.83707	165.18	2.54318	70.39	0.00639	18.66	0.81154	176.08
1.35	0.82469	164.00	2.60413	67.17	0.00664	17.14	0.80396	176.98
1.4	0.80971	162.76	2.68767	63.69	0.00686	15.10	0.79812	177.98
1.45	0.79087	161.42	2.79189	59.73	0.00707	12.45	0.79179	178.83
1.5	0.76847	160.03	2.91082	55.24	0.00723	8.99	0.78258	179.68
1.55	0.74126	158.60	3.04944	50.25	0.00735	4.62	0.77256	-179.28
1.6	0.70933	157.30	3.20126	44.67	0.00737	-0.89	0.76200	-178.18
1.65	0.67261	156.25	3.36356	38.42	0.00727	-7.59	0.75243	-176.93
1.7	0.63202	155.73	3.53052	31.45	0.00702	-15.85	0.74435	-175.63
1.75	0.59058	156.13	3.69596	23.72	0.00657	-25.99	0.73950	-174.33
1.8	0.55219	157.76	3.84647	15.21	0.00592	-38.78	0.73766	-173.25
1.85	0.53906	175.46	3.84639	5.98	0.00493	-55.47	0.74863	173.64
1.9	0.55077	-178.72	3.76728	-3.57	0.00394	-78.20	0.76239	172.14
1.95	0.58350	-174.08	3.61364	-13.31	0.00325	-110.26	0.77658	170.13
2	0.63044	-171.29	3.40538	-22.98	0.00325	-147.37	0.78891	167.72
2.05	0.68283	-170.32	3.15278	-32.28	0.00389	-177.72	0.79795	164.96
2.1	0.73327	-170.78	2.87824	-41.07	0.00480	161.34	0.80422	162.03
2.15	0.77875	-172.14	2.60183	-49.24	0.00576	146.52	0.80618	159.04
2.2	0.81666	-174.06	2.33461	-56.78	0.00658	135.49	0.80601	156.02
2.25	0.84807	-176.25	2.08577	-63.69	0.00728	126.95	0.80299	153.08
2.3	0.87279	-178.55	1.85911	-70.01	0.00782	120.20	0.79865	150.21
2.35	0.89261	179.07	1.65704	-75.82	0.00823	114.85	0.79341	147.45
2.4	0.90758	176.70	1.47812	-81.19	0.00851	110.74	0.78715	144.80
2.45	0.91984	174.31	1.32091	-86.22	0.00868	107.68	0.78067	142.25

Table 10. Class A Common Emitter S-Parameters at $V_{DC} = 5$ Vdc, $I_{DC} = 480$ mA, $T_C = 25^\circ\text{C}$ (continued)

f GHz	S_{11}		S_{21}		S_{12}		S_{22}	
	$ S_{11} $	$\angle \phi$	$ S_{21} $	$\angle \phi$	$ S_{12} $	$\angle \phi$	$ S_{22} $	$\angle \phi$
2.5	0.92917	171.99	1.18240	-90.93	0.00876	105.84	0.77298	139.76
2.55	0.93606	169.65	1.06136	-95.41	0.00878	105.17	0.76528	137.41
2.6	0.94249	167.38	0.95471	-99.69	0.00880	105.76	0.75557	135.15
2.65	0.94659	165.17	0.86109	-103.83	0.00882	107.70	0.74569	132.95
2.7	0.95002	163.00	0.77869	-107.89	0.00894	111.20	0.73387	130.86
2.75	0.95243	160.86	0.70576	-111.91	0.00932	116.13	0.72034	128.82
2.8	0.95418	158.70	0.64070	-115.96	0.01006	121.98	0.70405	126.97
2.85	0.95534	156.67	0.58229	-120.08	0.01141	127.95	0.68401	125.22
2.9	0.95570	154.64	0.52887	-124.40	0.01358	132.34	0.65990	123.77
2.95	0.95565	152.68	0.47907	-128.91	0.01662	134.33	0.63014	122.76
3	0.95487	150.86	0.43144	-133.65	0.02061	133.72	0.59605	122.51

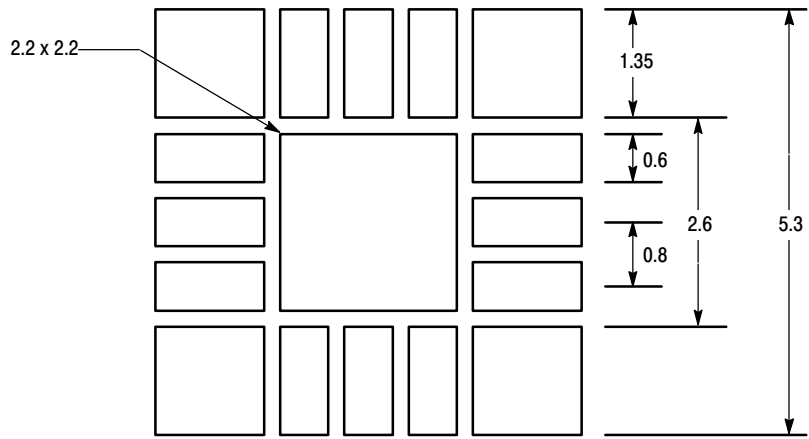

NOTES:

1. THERMAL AND RF GROUNDING CONSIDERATIONS SHOULD BE USED IN PCB LAYOUT DESIGN.
2. DEPENDING ON PCB DESIGN RULES, AS MANY VIAS AS POSSIBLE SHOULD BE PLACED ON THE BACKSIDE CENTER METAL GROUND LANDING PATTERN.
3. REFER TO FREESCALE APPLICATION NOTE AN2467 FOR ADDITIONAL PQFN PCB GUIDELINES.

Figure 25. Recommended Mounting Configuration



NOTES



NOTES



NOTES

How to Reach Us:

Home Page:

www.freescale.com

E-mail:

support@freescale.com

USA/Europe or Locations Not Listed:

Freescale Semiconductor
Technical Information Center, CH370
1300 N. Alma School Road
Chandler, Arizona 85224
+1-800-521-6274 or +1-480-768-2130
support@freescale.com

Europe, Middle East, and Africa:

Freescale Halbleiter Deutschland GmbH
Technical Information Center
Schatzbogen 7
81829 Muenchen, Germany
+44 1296 380 456 (English)
+46 8 52200080 (English)
+49 89 92103 559 (German)
+33 1 69 35 48 48 (French)
support@freescale.com

Japan:

Freescale Semiconductor Japan Ltd.
Headquarters
ARCO Tower 15F
1-8-1, Shimo-Meguro, Meguro-ku,
Tokyo 153-0064
Japan
0120 191014 or +81 3 5437 9125
support.japan@freescale.com

Asia/Pacific:

Freescale Semiconductor Hong Kong Ltd.
Technical Information Center
2 Dai King Street
Tai Po Industrial Estate
Tai Po, N.T., Hong Kong
+800 2666 8080
support.asia@freescale.com

For Literature Requests Only:

Freescale Semiconductor Literature Distribution Center
P.O. Box 5405
Denver, Colorado 80217
1-800-441-2447 or 303-675-2140
Fax: 303-675-2150
LDCForFreescaleSemiconductor@hibbertgroup.com

Information in this document is provided solely to enable system and software implementers to use Freescale Semiconductor products. There are no express or implied copyright licenses granted hereunder to design or fabricate any integrated circuits or integrated circuits based on the information in this document.

Freescale Semiconductor reserves the right to make changes without further notice to any products herein. Freescale Semiconductor makes no warranty, representation or guarantee regarding the suitability of its products for any particular purpose, nor does Freescale Semiconductor assume any liability arising out of the application or use of any product or circuit, and specifically disclaims any and all liability, including without limitation consequential or incidental damages. "Typical" parameters that may be provided in Freescale Semiconductor data sheets and/or specifications can and do vary in different applications and actual performance may vary over time. All operating parameters, including "Typicals", must be validated for each customer application by customer's technical experts. Freescale Semiconductor does not convey any license under its patent rights nor the rights of others. Freescale Semiconductor products are not designed, intended, or authorized for use as components in systems intended for surgical implant into the body, or other applications intended to support or sustain life, or for any other application in which the failure of the Freescale Semiconductor product could create a situation where personal injury or death may occur. Should Buyer purchase or use Freescale Semiconductor products for any such unintended or unauthorized application, Buyer shall indemnify and hold Freescale Semiconductor and its officers, employees, subsidiaries, affiliates, and distributors harmless against all claims, costs, damages, and expenses, and reasonable attorney fees arising out of, directly or indirectly, any claim of personal injury or death associated with such unintended or unauthorized use, even if such claim alleges that Freescale Semiconductor was negligent regarding the design or manufacture of the part.

Freescale™ and the Freescale logo are trademarks of Freescale Semiconductor, Inc. All other product or service names are the property of their respective owners.
© Freescale Semiconductor, Inc. 2005. All rights reserved.

RoHS-compliant and/or Pb-free versions of Freescale products have the functionality and electrical characteristics of their non-RoHS-compliant and/or non-Pb-free counterparts. For further information, see <http://www.freescale.com> or contact your Freescale sales representative.

For information on Freescale's Environmental Products program, go to <http://www.freescale.com/epp>.

