



Coaxial Directional Coupler, 18 to 40 GHz, 10 dB Coupling Level

Description:

SCD-1834031012-KF-SA is a 10 dB coaxial directional coupler that covers the frequency range of 18 to 40 GHz. The nominal insertion loss of the coupler is 1.5 dB and the coupling ripple is ± 1.0 dB. The directivity of the coupler is 12 dB. The RF connectors of the coupler are 2.92 mm (K) female connectors. The power handling of the coupler is 20 watts maximum. Other configurations, such as different connectors for input and output, are available under different model numbers.



Features:

- Low Insertion Loss
- Flat Coupling Level

Applications:

- Test Labs
- Instrumentations
- Sub-assemblies

Electrical Specifications:

Parameter	Minimum	Typical	Maximum
Frequency	18 GHz		40 GHz
Insertion Loss		1.5 dB	
Coupling		10 dB	
Coupling Flatness		± 1.0 dB	
Directivity		12 dB	
Port Return Loss		14 dB	
Impedance		50 Ω	
Power Handling			20 W (CW)
Specification Temperature		+25 °C	
Operating Temperature	-40 °C		+80 °C

Mechanical Specifications:

Item	Specification
RF Ports	2.92 mm Female
Case Material	Aluminum
Finishing	Black Painted
Outline	CD-KS-SR11



Coaxial Directional Coupler, 18 to 40 GHz, 10 dB Coupling Level

Typical Coupling and Directivity vs. Frequency

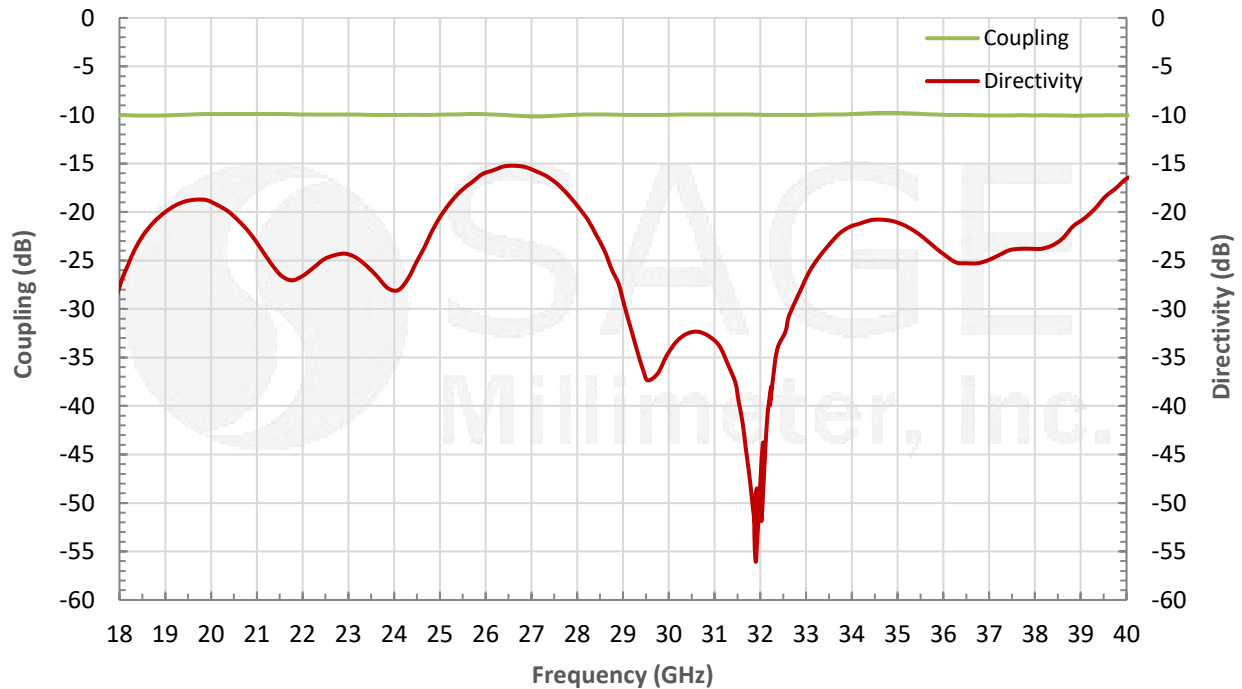

Typical Performance vs. Frequency

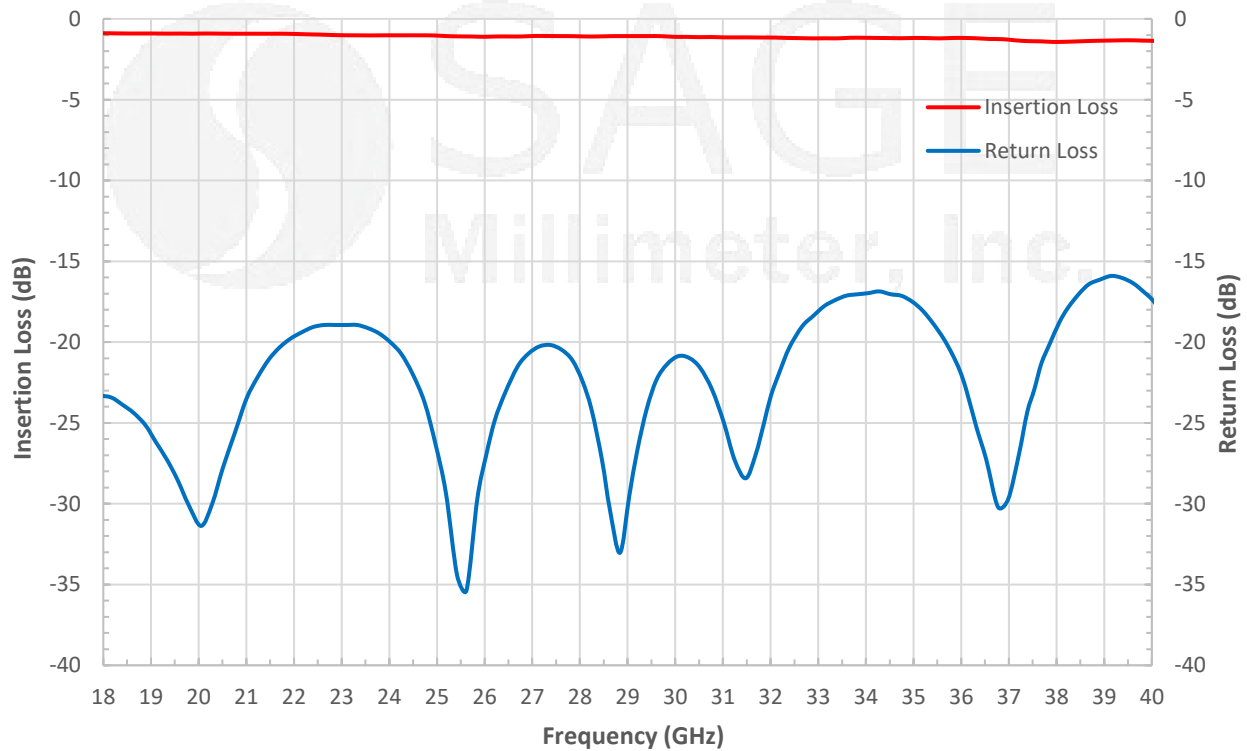



Coaxial Directional Coupler, 18 to 40 GHz, 10 dB Coupling Level

Mechanical Outline: (Unless otherwise specified, all dimensions are in inches [millimeters])

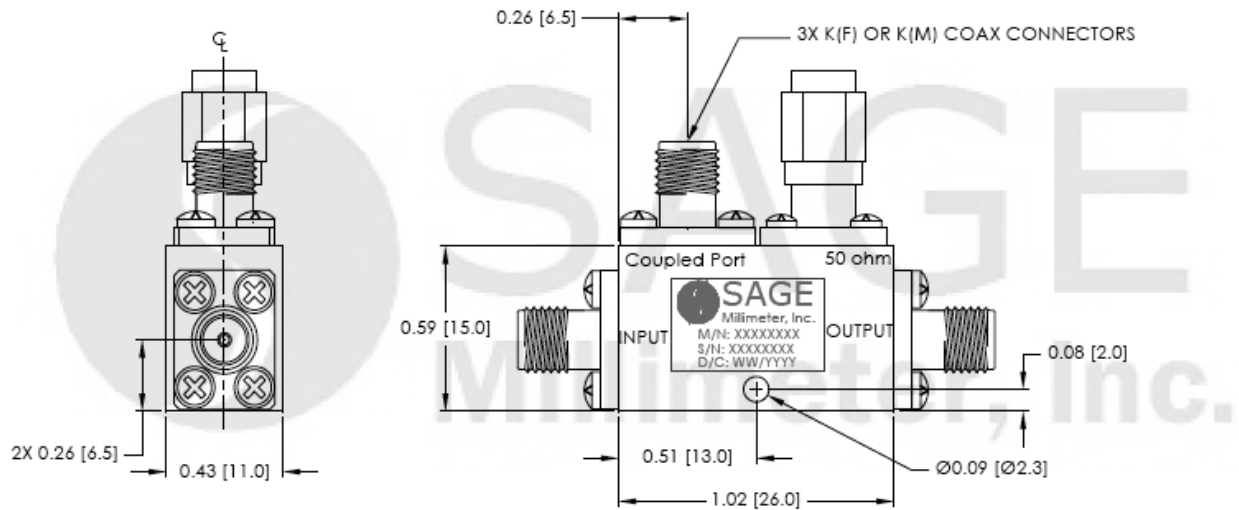

Note:

- All data presented is collected from a sample lot. Actual data may vary unit to unit, slightly.
- All testing was performed under +25 °C case temperature.
- SAGE Millimeter, Inc. reserves the right to change the information presented without notice.

Caution:

- Proper torque, 8.0 ± 0.15 inch-pounds (0.90 ± 0.02 Nm) shall be used. **SAGE Millimeter torque wrench with model number SCH-08008-U3 is highly recommended.**