

Coaxial Frequency Mixer

Level 7 (LO Power +7 dBm) 0.04 to 400 MHz

ZFM-3+



SMA version shown
CASE STYLE: K18

Connectors	Model
BNC	ZFM-3+
SMA	ZFM-3-S+
BRACKET (OPTION "B")	

+RoHS Compliant

The +Suffix identifies RoHS Compliance. See our web site for RoHS Compliance methodologies and qualifications

Maximum Ratings

Operating Temperature	-55°C to 100°C
Storage Temperature	-55°C to 100°C
RF Power	50mW
IF Current	40mA
Permanent damage may occur if any of these limits are exceeded.	

Coaxial Connections

LO	1
RF	2
IF	3

Features

- low conversion loss, 4.78 dB typ.
- high L-R isolation, 50 dB typ, L-I, 45 dB typ.
- rugged shielded case

Applications

- VHF
- FM radio
- defense & federal communications
- instrumentation

Outline Drawing

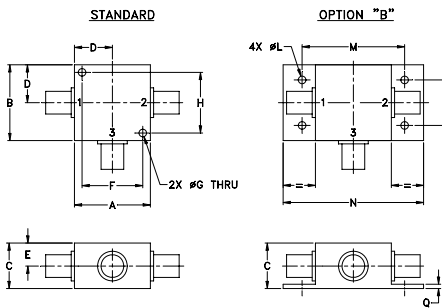

Outline Dimensions (inch/mm)

A	B	C	D	E	F	G	H
1.25	1.25	.75	.63	.38	1.00	.125	1.000
31.75	31.75	19.05	16.00	9.65	25.40	3.18	25.40
J	K	L	M	N	P	Q	wt
--	--	.125	1.688	2.18	.75	.07	grams
--	--	3.18	42.88	55.37	19.05	1.78	70.0

Electrical Specifications

FREQUENCY (MHz)		CONVERSION LOSS (dB)				LO-RF ISOLATION (dB)						LO-IF ISOLATION (dB)					
LO/RF	IF	Mid-Band		Total	Max.	L		M		U		L		M		U	
f_L - f_U		\bar{X}	σ	Range		Typ.	Min.	Typ.	Min.	Typ.	Min.	Typ.	Min.	Typ.	Min.	Typ.	Min.
0.04-400	DC-400	4.78	0.03	7.0	8.0	60	50	50	35	35	25	55	40	45	30	35	25

1 dB COMP: +1 dBm typ.

L = low range [f_L to $10 f_L$] M = mid range [$10 f_L$ to $f_U/2$] U = upper range [$f_U/2$ to f_U]
m = mid band [$2f_L$ to $f_U/2$]

Typical Performance Data

Frequency (MHz)		Conversion Loss (dB)	Isolation L-R (dB)	Isolation L-I (dB)	VSWR RF Port (:1)	VSWR LO Port (:1)
RF	LO	LO +7dBm	LO +7dBm	LO +7dBm	LO +7dBm	LO +7dBm
0.04	30.04	6.15	>67.00	>67.00	1.24	2.69
0.05	30.05	5.52	>67.00	>67.00	1.25	2.55
0.07	30.07	5.12	>67.00	>67.00	1.25	2.67
0.10	30.10	4.92	>67.00	>67.00	1.24	2.63
0.50	30.50	4.77	>67.00	>67.00	1.23	2.55
1.00	31.00	4.76	>67.00	63.53	1.23	2.45
5.00	35.00	4.75	>67.00	60.91	1.21	2.48
10.00	40.00	4.75	>67.00	60.97	1.21	2.42
20.00	50.00	4.74	>67.00	58.52	1.19	2.42
60.87	90.87	4.73	50.40	49.37	1.18	2.36
100.00	70.00	4.63	44.80	44.05	1.16	2.38
162.61	132.61	4.79	39.22	39.87	1.15	2.46
200.00	170.00	4.95	37.18	37.86	1.13	2.40
230.44	200.44	4.89	35.78	37.67	1.13	2.42
281.31	251.31	5.05	33.68	35.71	1.13	2.41
315.23	285.23	5.25	34.22	33.98	1.14	2.56
349.14	319.14	5.32	35.64	34.07	1.14	2.63
366.10	336.10	5.37	35.56	34.58	1.14	2.68
383.05	353.05	5.44	35.25	34.26	1.15	2.69
400.00	370.00	5.56	34.72	32.46	1.15	2.76

Electrical Schematic

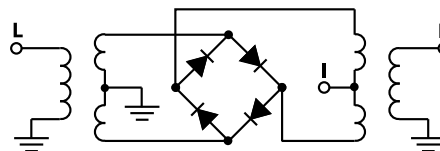

Notes

- Performance and quality attributes and conditions not expressly stated in this specification document are intended to be excluded and do not form a part of this specification document.
- Electrical specifications and performance data contained in this specification document are based on Mini-Circuit's applicable established test performance criteria and measurement instructions.
- The parts covered by this specification document are subject to Mini-Circuits standard limited warranty and terms and conditions (collectively, "Standard Terms"); Purchasers of this part are entitled to the rights and benefits contained therein. For a full statement of the Standard Terms and the exclusive rights and remedies thereunder, please visit Mini-Circuits' website at www.minicircuits.com/MCLStore/terms.jsp



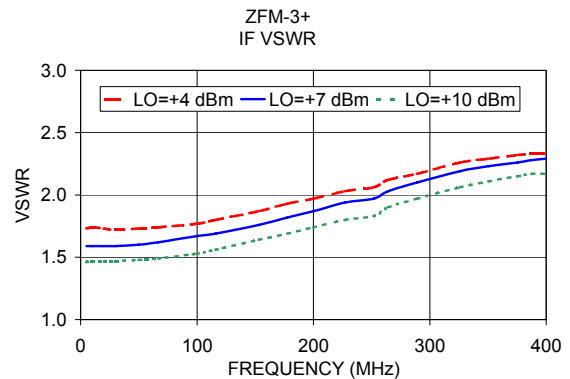
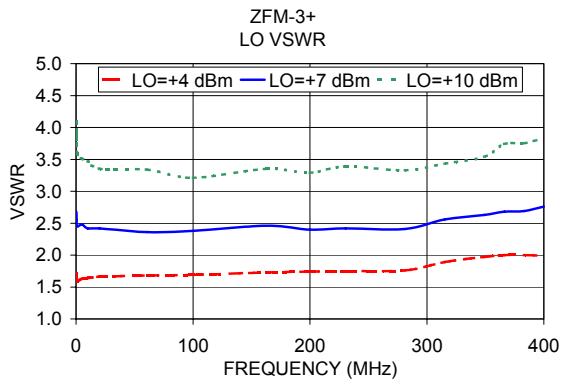
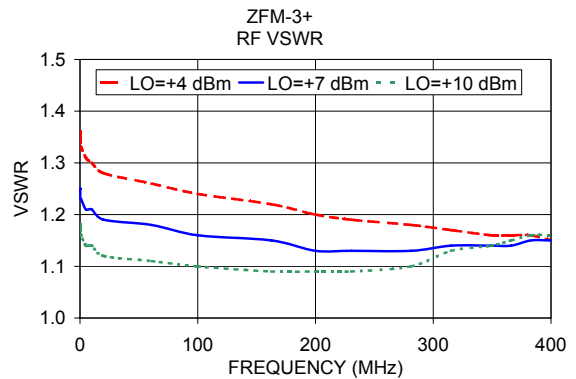
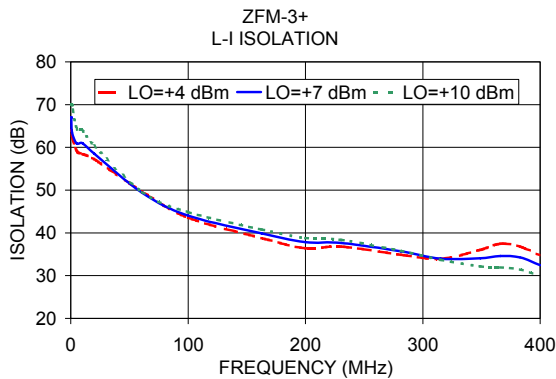
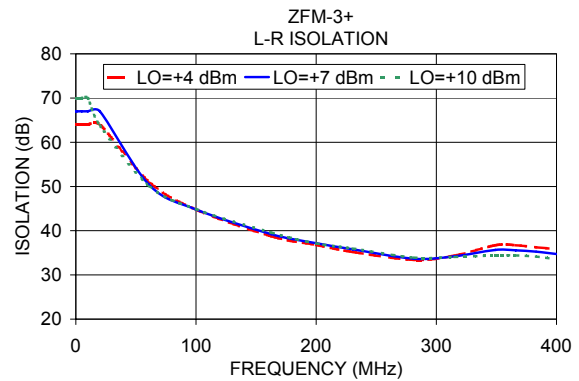
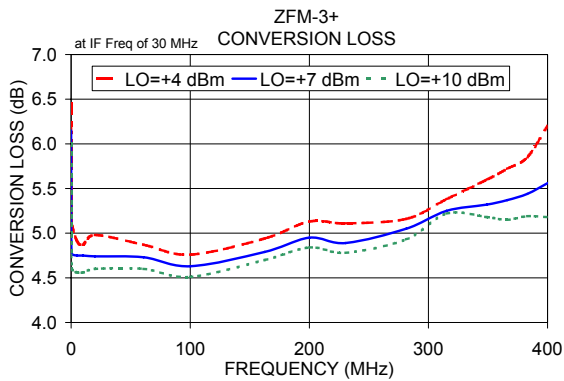

Notes

- A. Performance and quality attributes and conditions not expressly stated in this specification document are intended to be excluded and do not form a part of this specification document.
- B. Electrical specifications and performance data contained in this specification document are based on Mini-Circuit's applicable established test performance criteria and measurement instructions.
- C. The parts covered by this specification document are subject to Mini-Circuits standard limited warranty and terms and conditions (collectively, "Standard Terms"); Purchasers of this part are entitled to the rights and benefits contained therein. For a full statement of the Standard Terms and the exclusive rights and remedies thereunder, please visit Mini-Circuits' website at www.minicircuits.com/MCLStore/terms.jsp

