

JSO-01-465/3S

4 PORT 3 DB SMA 180° HYBRID COUPLER

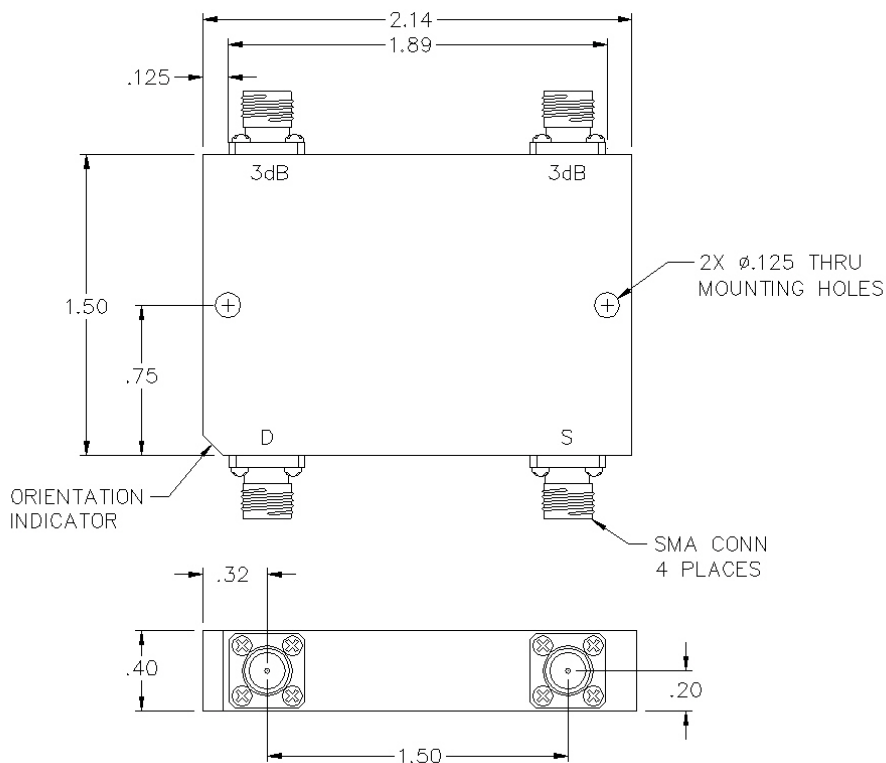

SPECIFICATIONS

Name:	JSO-01-465/3S
Frequency Range:	1-2 GHz
Insertion Loss:	0.6 dB max.
Isolation A-B:	22 dB min.
Power Rating:	80 watts max.
Amplitude Balance:	± 0.5 dB max.
Phase Balance:	$\pm 8^\circ$ max.
VSWR:	1.40:1 max.
Connector Type:	SMA

Dimensions are in inches. Decimal tolerance: 2 Place: $\pm .02$, 3 Place: $\pm .010$
All specifications are subject to change without notice at any time. Rev: 190326

www.pulsarmicrowave.com · 48 Industrial St West, Clifton NJ 07012 · Tel: 973-779-6262 · Fax: 973-779-2727 · sales@pulsarmicrowave.com

PULSAR
MICROWAVE CORPORATION