

JF-03-412

4 PORT 3 DB SMA 180° HYBRID COUPLER

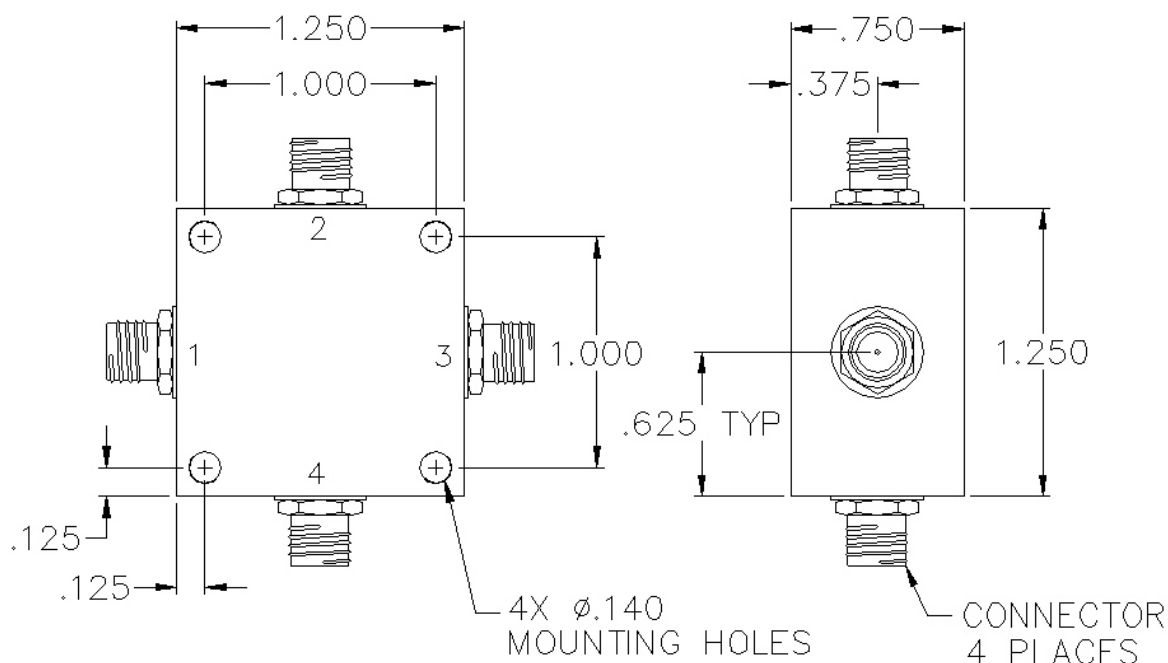

SPECIFICATIONS

Name:	JF-03-412
Frequency Range:	5-400 MHz
Insertion Loss:	1.5 dB max.
Isolation A-B:	20 dB min.
Input Power:	1 watts max.
Amplitude Balance:	0.4 dB max.
Phase Balance:	6° max.
VSWR:	1.50:1 max.
Package Type:	SMA

PORT CONFIGURATION

Delta:	2
Sum:	4
A (0°):	1
B (180°):	3
Ground:	Housing

Amplitude balance is defined by input Sum or Delta to output A & B.
SMA female connectors standard, also available with BNC, TNC, F, and N connectors.