

QE-06-412

3 DB SMA 90° HYBRID COUPLER

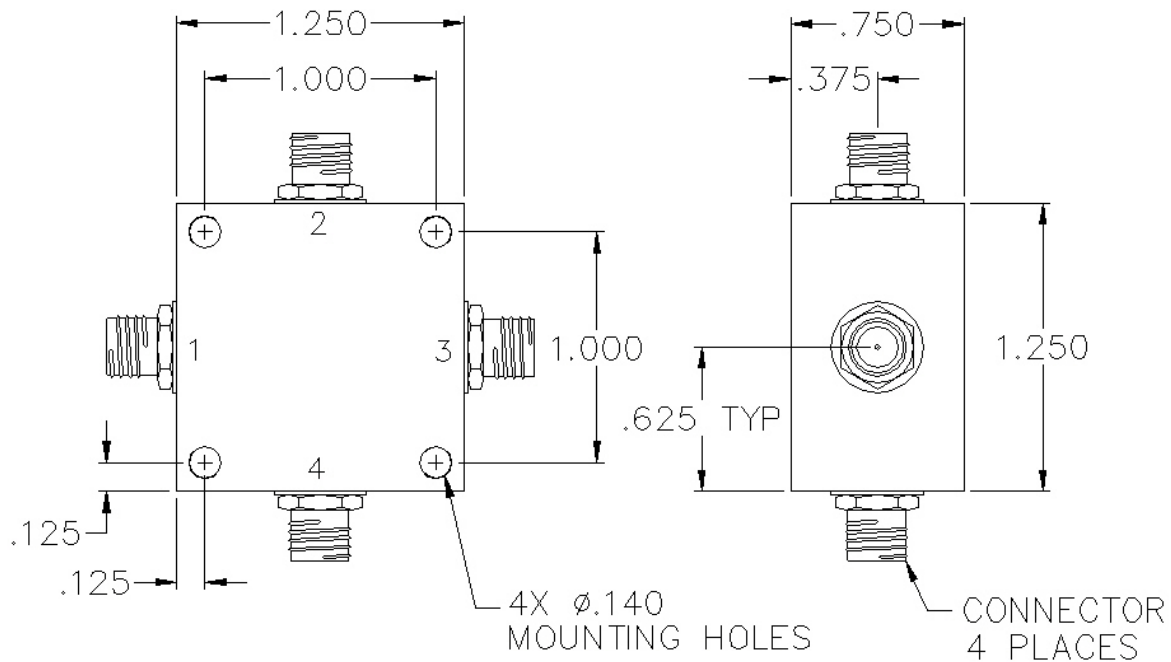

SPECIFICATIONS

Name:	QE-06-412
Bandwidth:	5:1
Frequency Range:	40-200 MHz
Insertion Loss:	0.6 dB max.
Isolation:	20 dB min.
Amplitude Balance:	0.5 dB max.
Phase Balance:	3° max.
VSWR:	1.40:1 max.
Package Type:	SMA

Power rating 1 watt max. for load VSWR better than 1.20:1.
SMA female connectors standard, also available with BNC, TNC, F, and N connectors.